

BRUCHA panel DP

roof

PIR+
nonhalogen

iQTec[®]
foam technology[®]

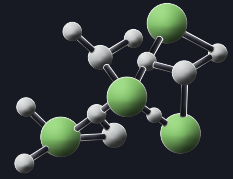

Minimum roof pitch 3° (5.2 %) without transverse joint and penetration.

BRUCHA panel DP with PIR/polyurethane core can be combined with BRUCHA panel DP-F with mineral wool core.

TRAPEZOID PROFILE exterior

close-up

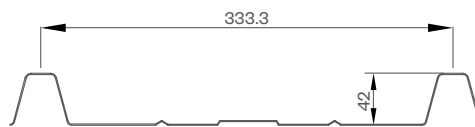

symbol image - DP

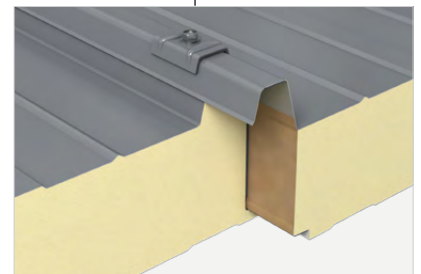

DETAIL/joint geometry

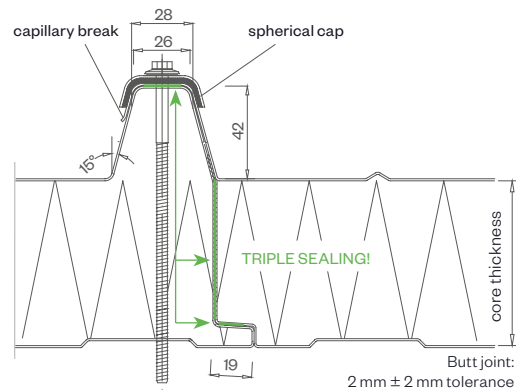

PANEL TYPE	DP 72	DP 82	DP 92**	DP 102	DP 122	DP 142	DP 162	DP 182	DP 202
core thickness mm	30	40	50	60	80	100	120	140	160
PIR+ nonhalogen U-value W/m ² K - EN 14509 including joint section	0.661	0.504	0.407	0.341	0.257	0.207	0.173	0.149	0.130
iQTec on request U-value W/m ² K - EN 14509 including joint section	0.575	0.437	0.352	0.294	0.222	0.178	0.149	0.128	0.112
weight kg/m ²	9.80	10.22	10.63	11.05	11.89	12.72	13.55	14.39	15.22

**DP 92 on request

MANUFACTURING TOLERANCES

in line with EN 14509

SOUND INSULATION

26 dB at 60/80 mm, 27 dB from 100 mm core thickness

MANUFACTURING LENGTHS

max. 21.5 m (extra-long transport from 13.6 m)

TEMPERATURE RESISTANCE

80 °C

SPAN WIDTH TABLES

according SandStat. calculation

FIRE BEHAVIOR

in line with EN 13501-1, Euroclass Bs1d0

BRUCHA[®]

BRUCHA panel DP roof

DESIGN AND SURFACES Standard - coil-coated, hot-dip galvanised steel sheet

EXTERIOR

- Exposed side 25 µm polyester coating with a PVC protective film (protects against solar radiation). The film must be removed no later than 10 weeks after the production date (visible on the longitudinal joint of the panel).
- profile: Trapezoidal profile, 42 mm (according to diagram)
- crown distance: 333.3 mm
- metal gauge: 0.6 mm (smaller metal gauge on request)

INTERIOR

- Exposed side has 25 µm polyester coating without protective PVC film (if required, please specify with order).
- profile 1 = standard (profile 2 and 3 on request)
- metal gauge: 0.6 mm (smaller metal gauge on request)

INSULATION CORE

- **nonhalogen** PIR/polyurethane rigid foam, approx. 96 % closed cells, continuously foamed
- absolutely no chlorofluorocarbons or halogenated chlorofluorocarbons – pentane foam process
- low thermal conductivity
- securely attached to the steel sheet
- density approx. 40 kg/m³

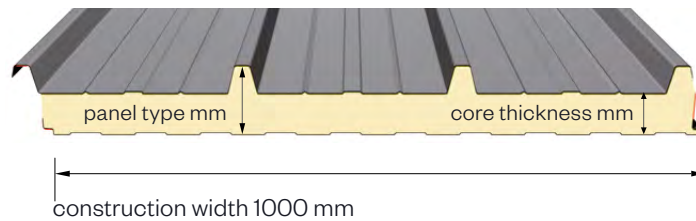

STANDARD COLORS

in accordance with BASIC color range

PANEL CONNECTION

- External, by overlapping of the corrugations, whereby the non-foamed sheet of a panel is placed over the corresponding section of the next panel.
- On the underside, by special shaping, whereby the complementary profile to the corrugation of one roof panel overlaps the corrugation of the second panel, thus achieving a tight connection.
- Unique **TRIPLE SEALING SYSTEM** (as per diagram) offers optimal condensate protection.
- capillary break (refer drawing)

TENDER TEXT

download from: brucha.com

EXTERNAL MONITORING

National and international tests and quality standards. We will send the certificates on request.



brucha.com



BRUCHA panel DP roof

PIR+
nonhalogen

iQTec[®]
foam technology[®]

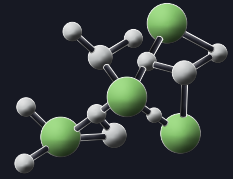

SHEET METAL SEPARATION CUT – NOTCHES

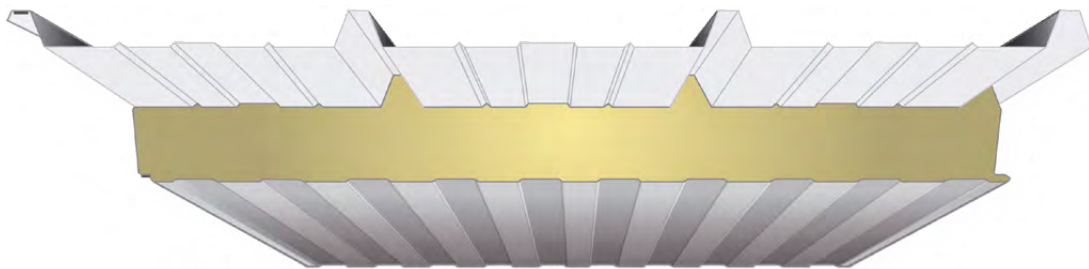

A notch in the eave area is recommended in order to rule out any possibility of the sheet metal shell lifting up from the insulation body (available at a surcharge).

Similarly, a drip cap should be fitted in the eave area so as to prevent a capillary effect (only possible on the construction site). These measures prevent the formation of corrosion between the sheet metal shell and the insulation.

Please state when ordering	Notch length
NOTCH IN EAVE	60 mm (Standard)
NOTCH FOR OVERLAP	200 mm (Standard)

Possible notch lengths 60, 80 100, 120, 150, 200, 250 and 300 mm

TRAPEZOID METAL SHEET 42/333 suitable for DP and DP-F

NOTCH METHOD (viewed from eave):

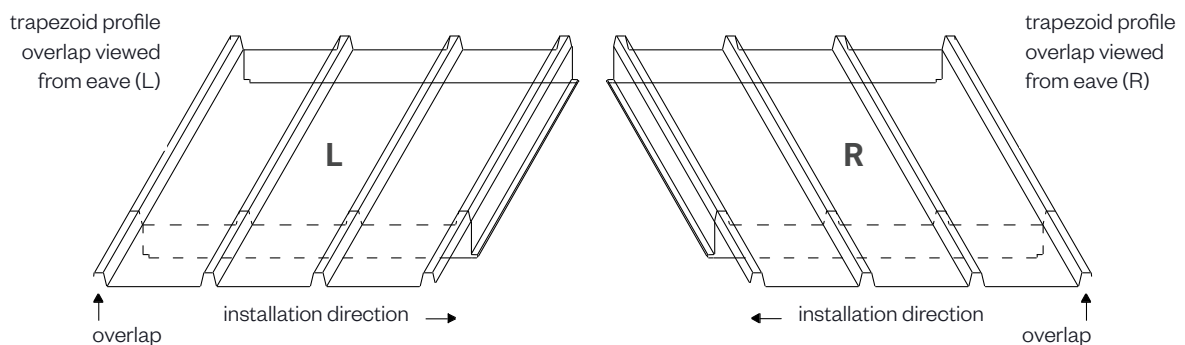

BRUCHA[®]

BRUCHA panel DP roof

ROOF ELEMENTS WITH TRANSVERSE JOINT AND OVERLAP

With transverse joints, penetrations or roof lights – minimum pitch 5° (8.6 %)

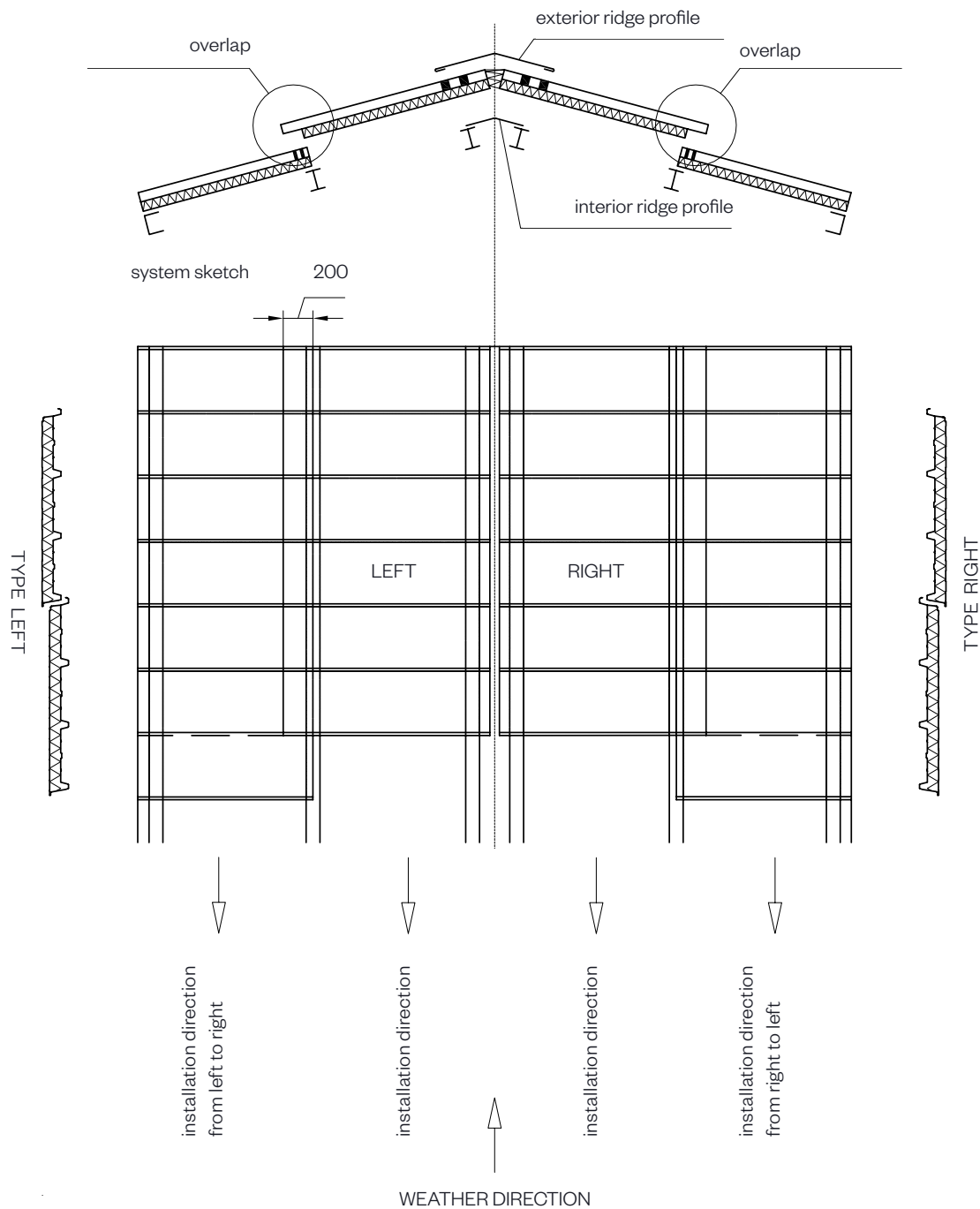

BRUCHA panel DP-L roof light

PIR+
nonhalogen

iQTec[®]
foam technology[®]

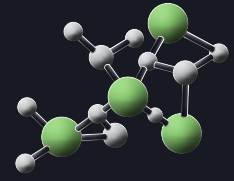

Minimum roof pitch 5° (8.6 %)

- Installation without system change of the BRUCHA panel PIR+/iQTec roof – DP is possible.
- No additional substructure necessary.
- Multiple roof lights can be installed adjacent to one another.
- High strength thanks to double-skin multi-wall light elements made from polycarbonate.
- Grid interlayer for fall-through protection.
- Evidence of load capacity - spot loading max. 4.5 KN (including reduction), accessibility test - for DP-L 142 TU Darmstadt (IFSW) - PB 18/18p
- Light transmission 70 %, UV resistant.
- Including apron plate on ridge side.
- Outstanding insulation characteristics.
- Fire behavior in accordance with EN 13501-1, Euroclass B, flame-retardant.

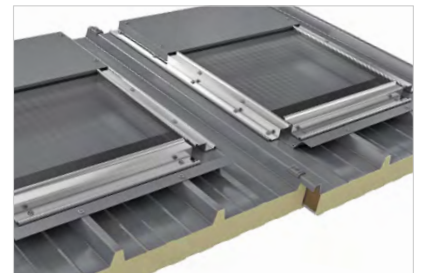

symbol image - DP roof

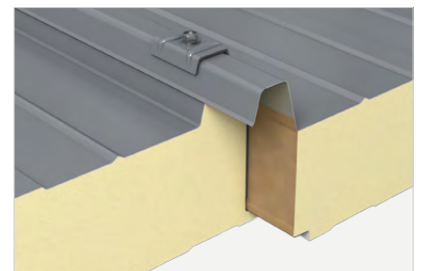

PANEL TYPE	DP-L 82	DP-L 102	DP-L 122	DP-L 142	DP-L 162	DP-L 182	DP-L 202
core thickness mm	30	40	50	60	80	100	120
U-value W/m ² K*	~0.81	~0.73	~0.73	~0.64	~0.64	~0.64	~0.64

*U-values are calculated mathematically and are approximate.

DP-L without approval for Germany

BRUCHA[®]

PIR+
nonhalogen

iQTec[®]
foam technology

BRUCHA panel DP-L roof light

Minimum roof pitch 5° (8.6 %)



planning grid: 1000 mm

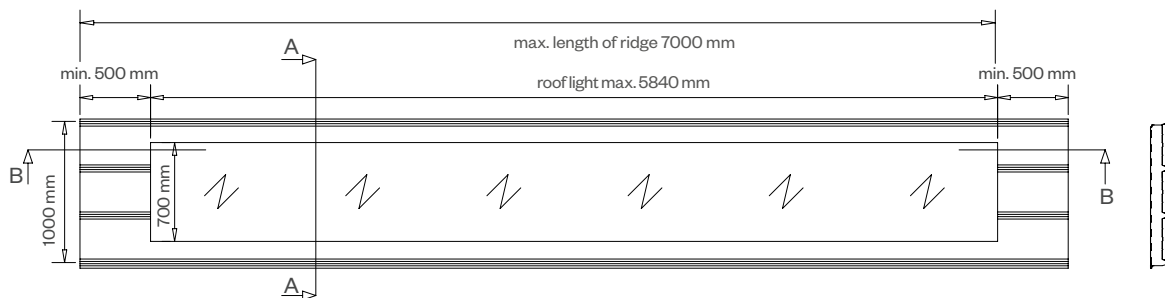

system cross-section A-A – transverse

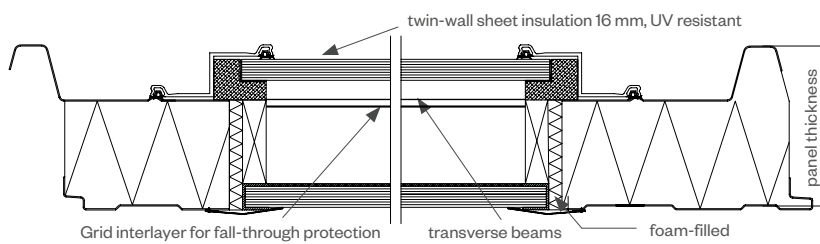

system cross-section B-B – longitudinal

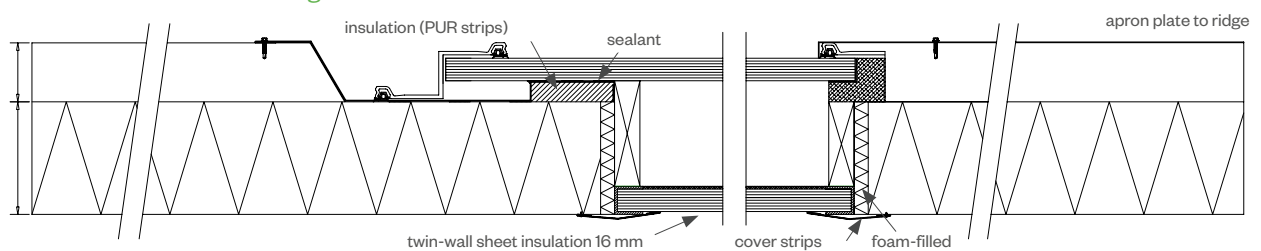

We will be happy to send certificates on request!

brucha.com

All information is considered to be subject to errors in composition or printing errors.