

EVOLUTION

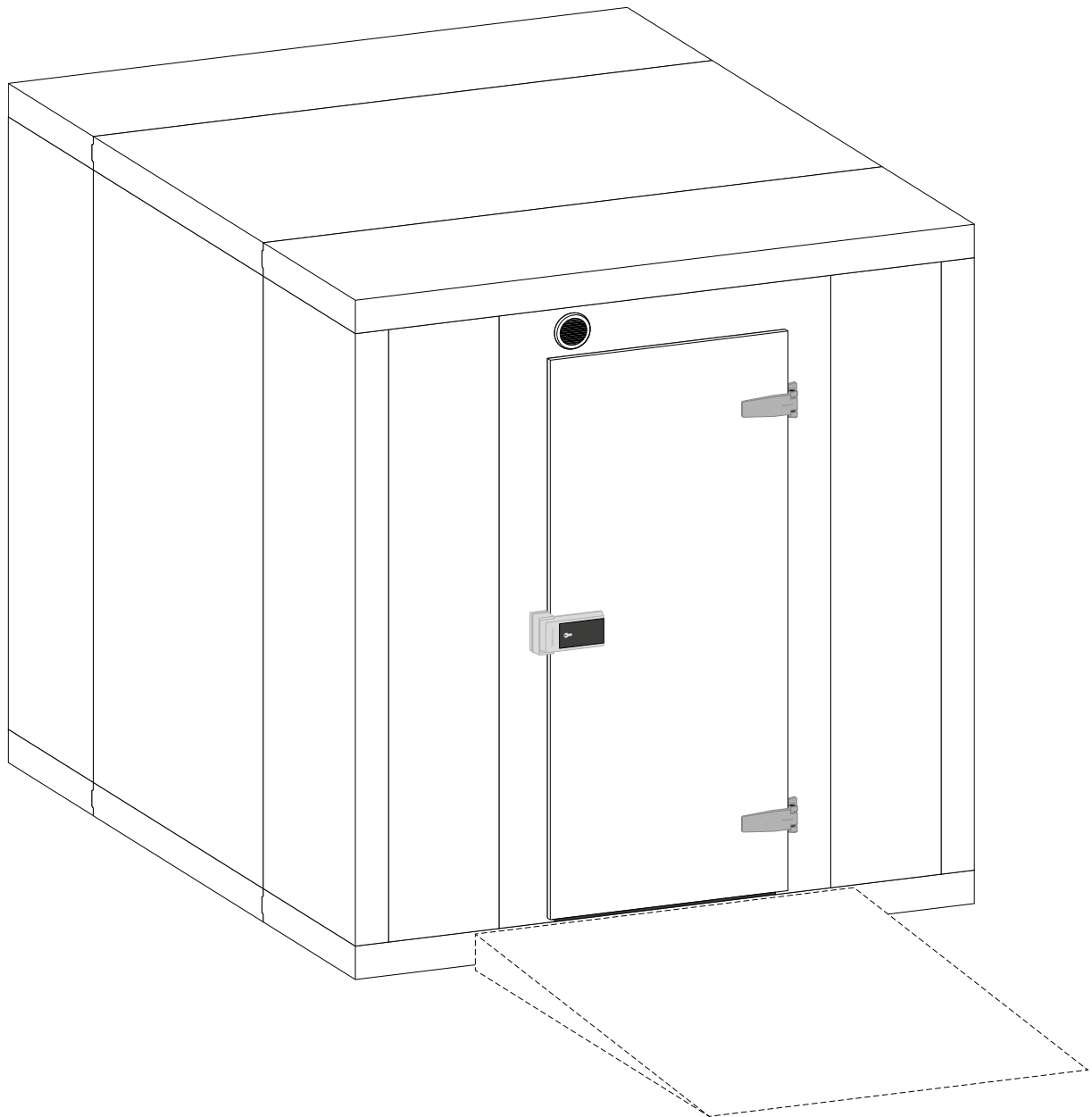



150 x 150 mm
5 7/8"



150 x 150 mm
5 7/8"

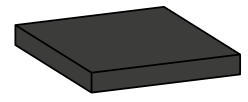

ø 17 x 6,5 mm
1/4"

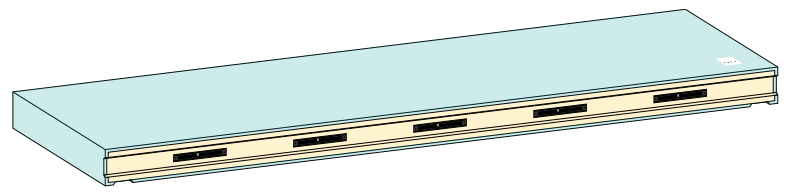

D_

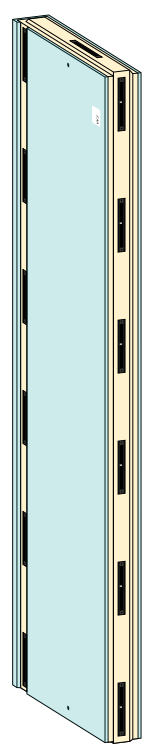

W_

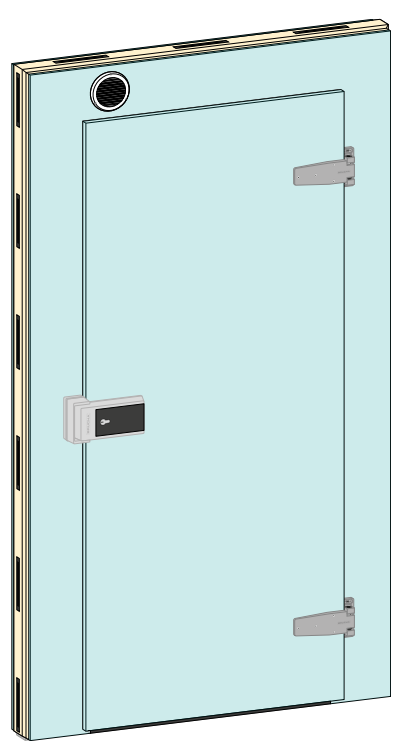

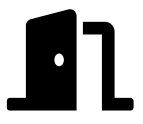
W 

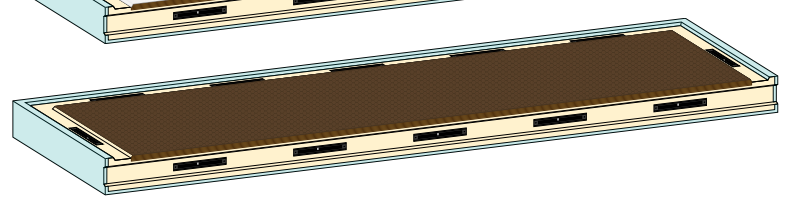
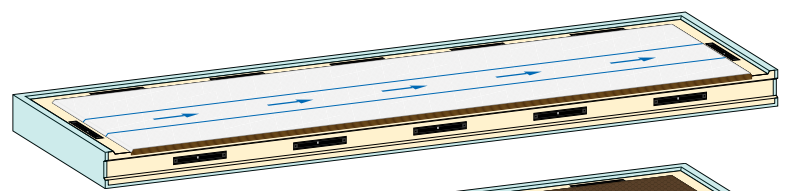
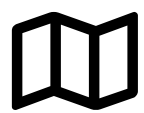

B_

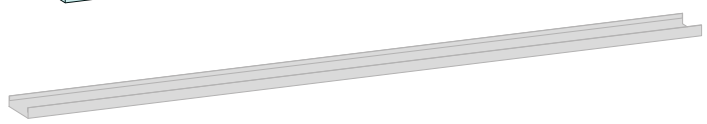

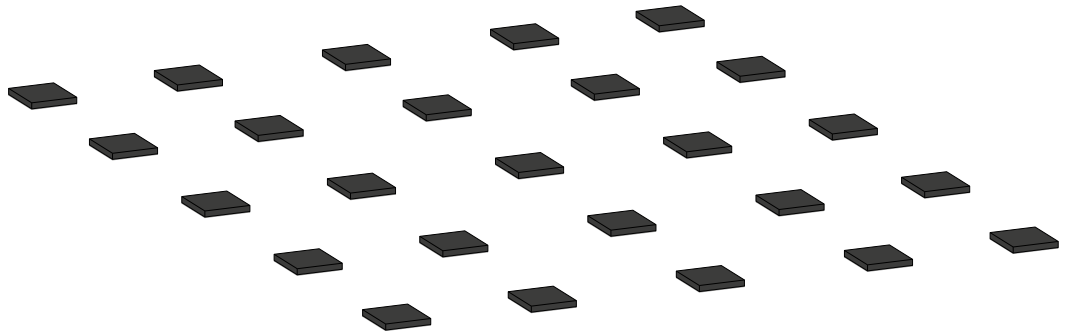

B_?

1 - 3



4 - 5

  $< 0^{\circ}\text{C} / 32^{\circ}\text{F}$

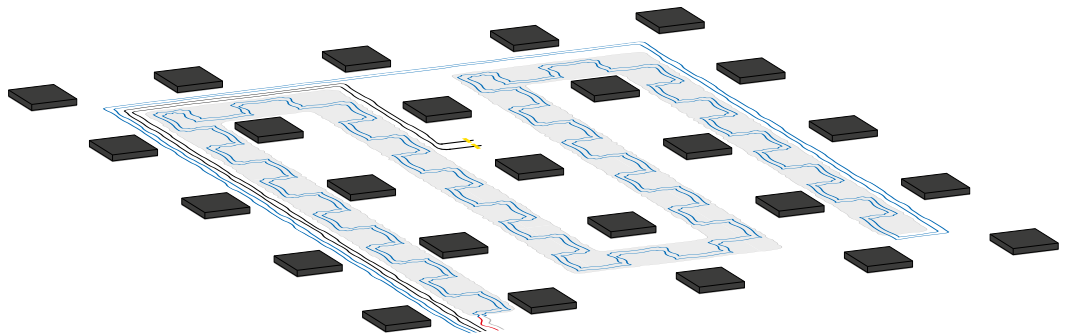

6 - 9

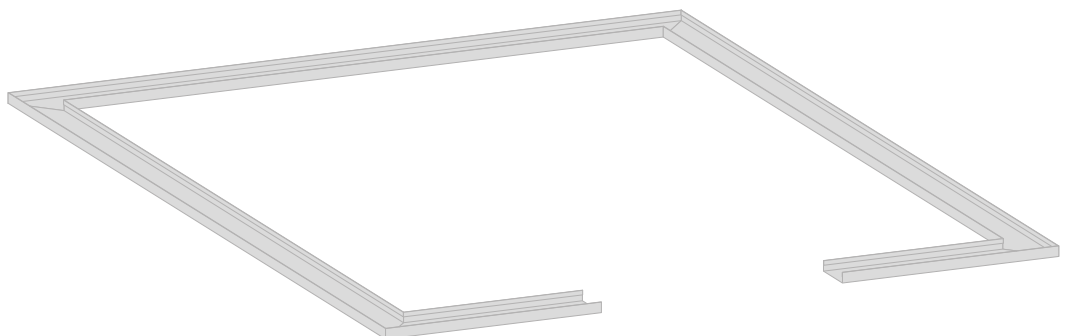

1

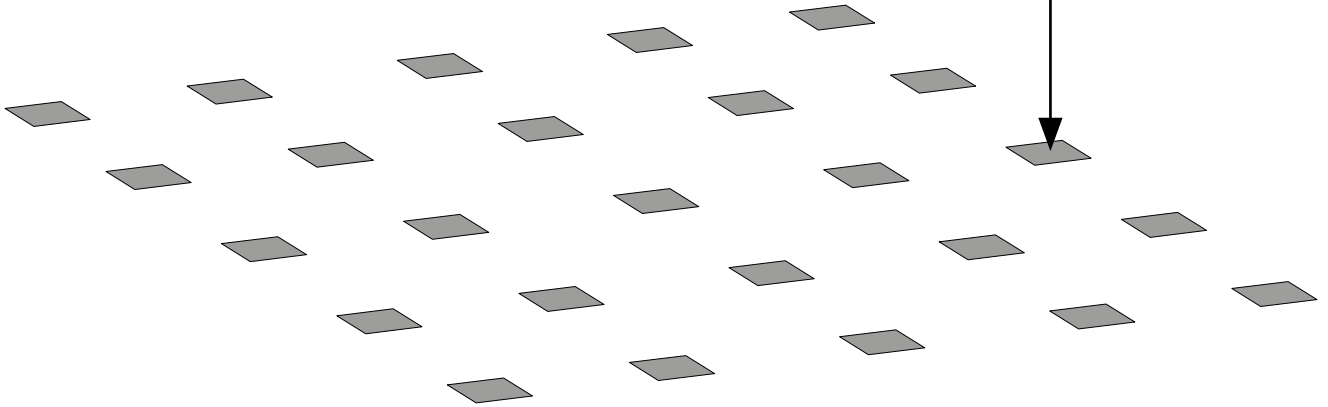
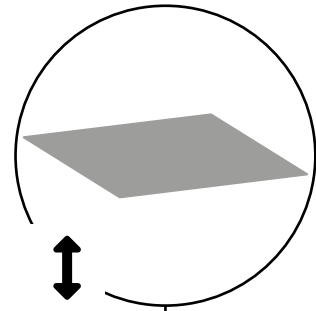
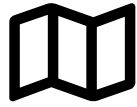

2

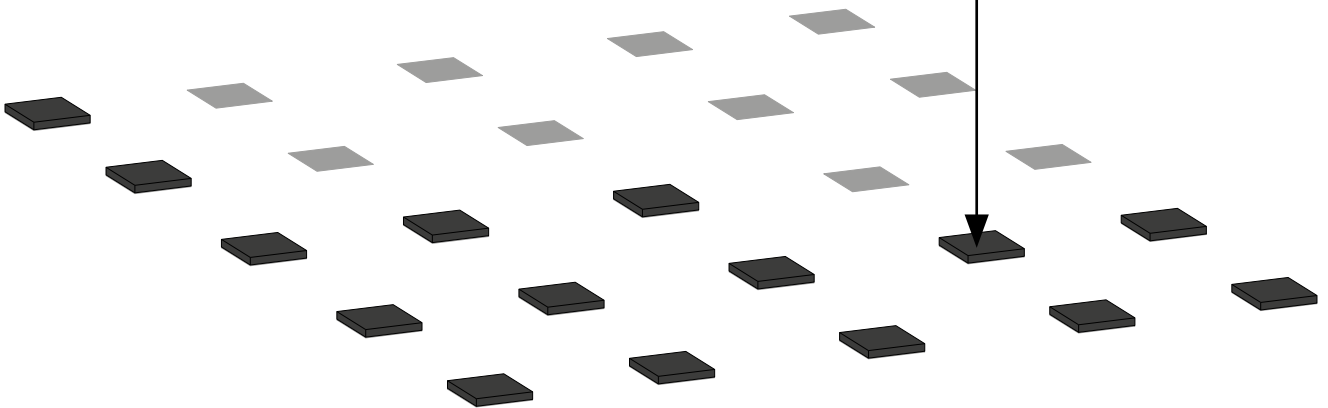
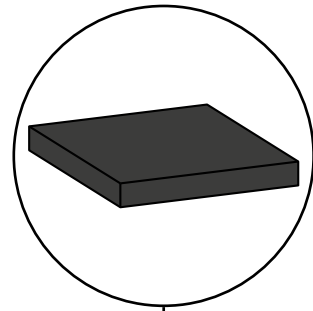

3

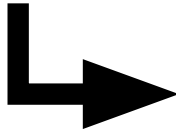
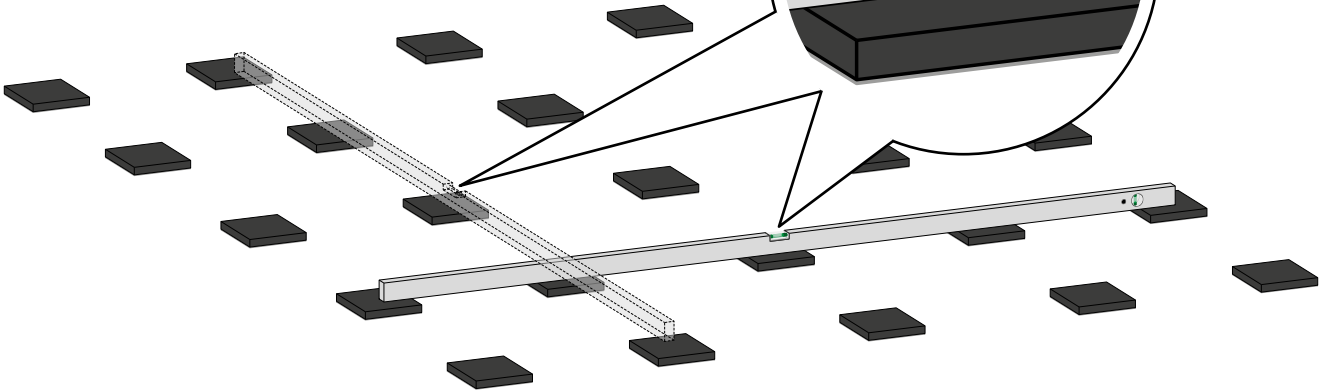
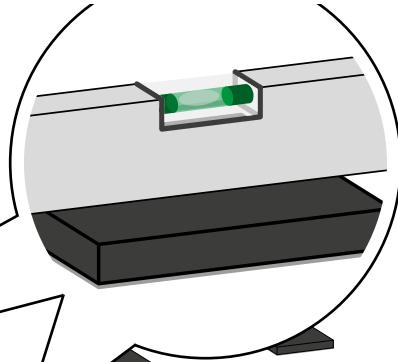

10

4



< 0 °C / 32 °F

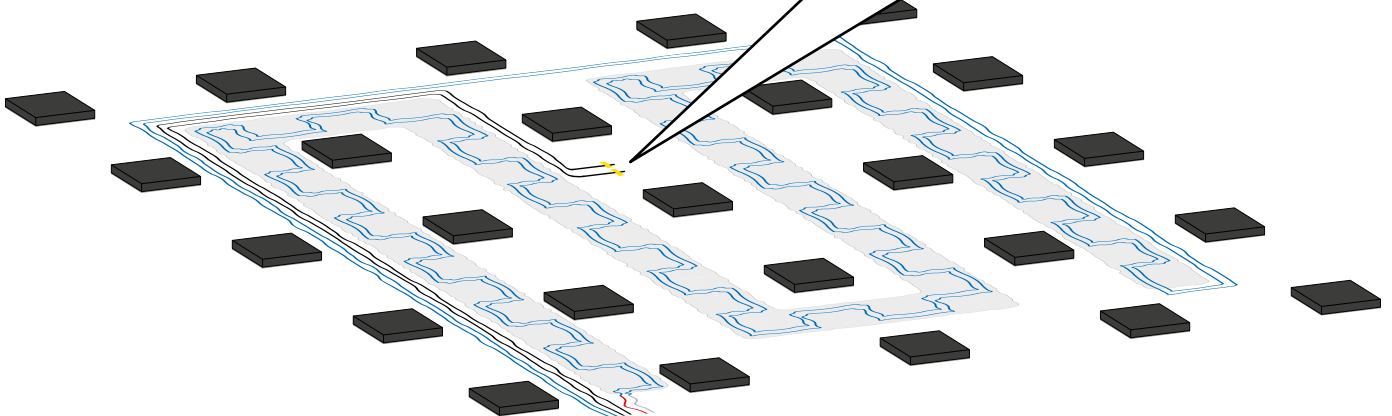
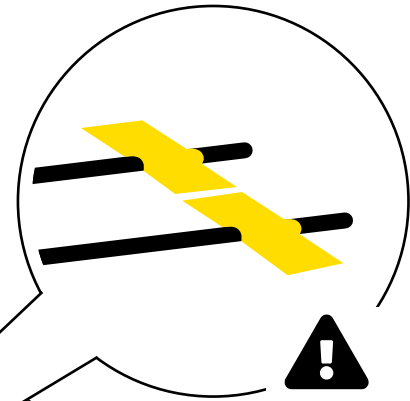

5

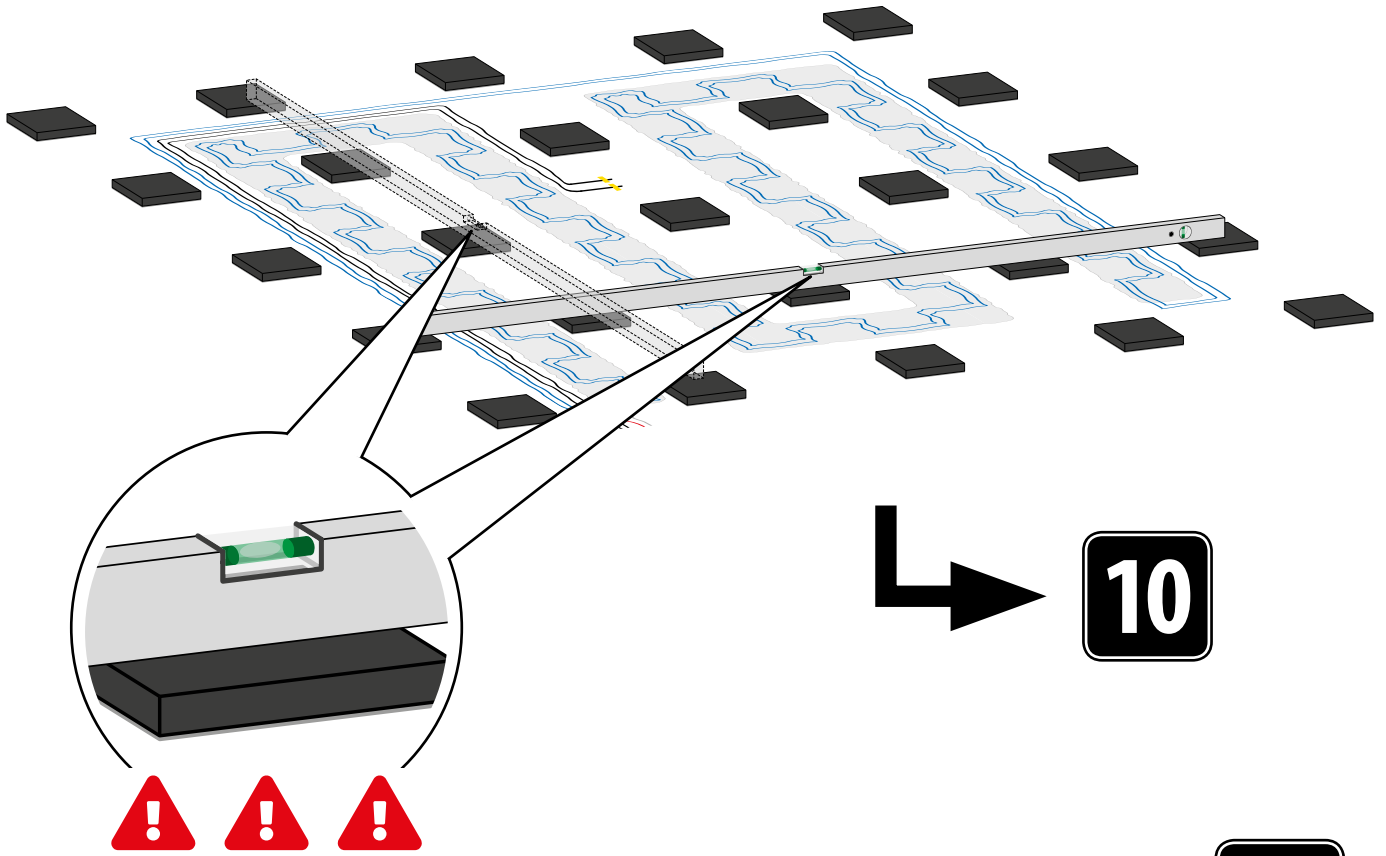

6

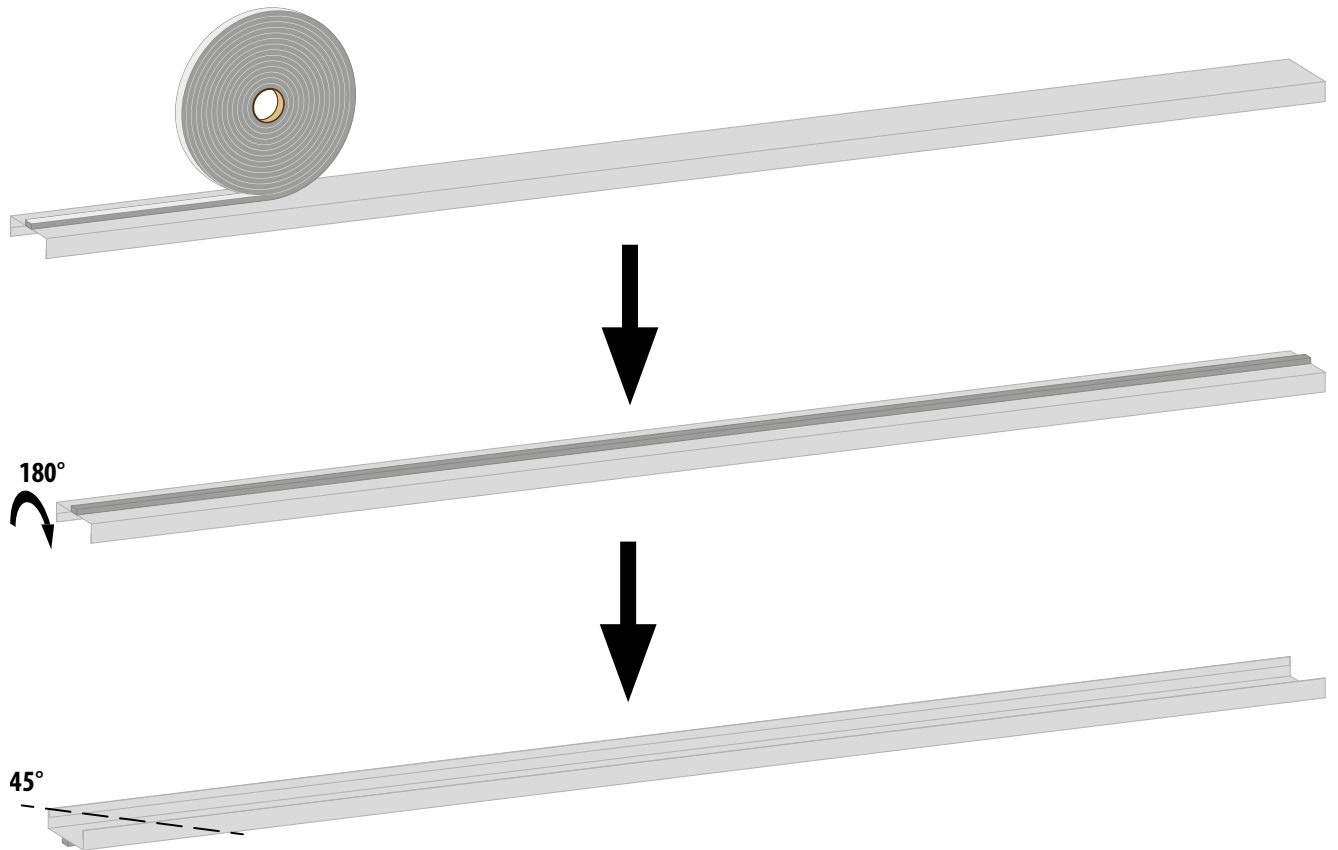

7

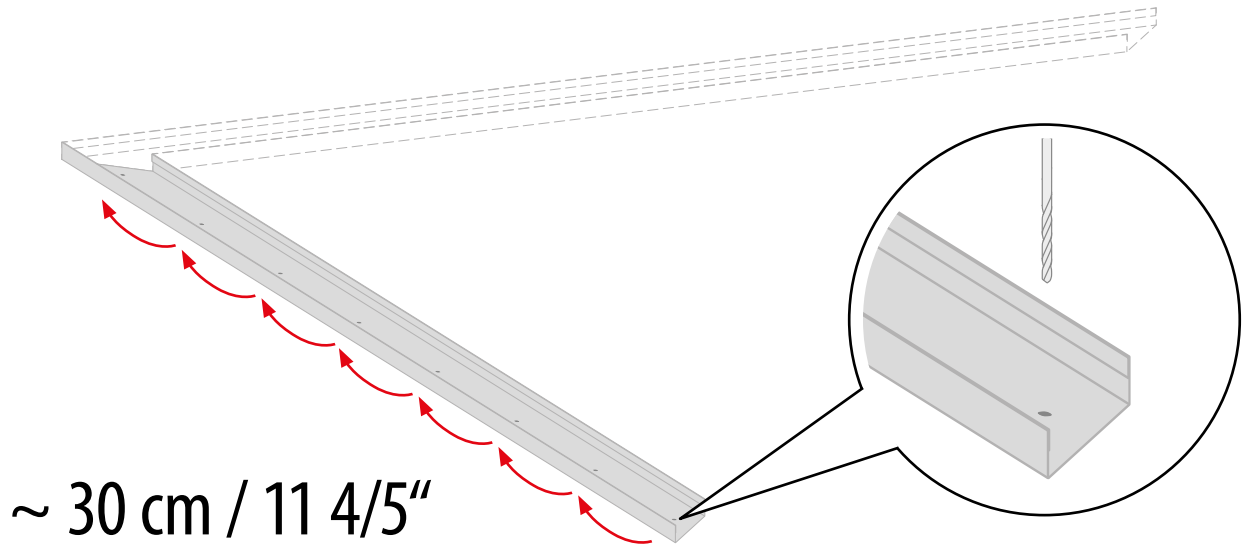

8

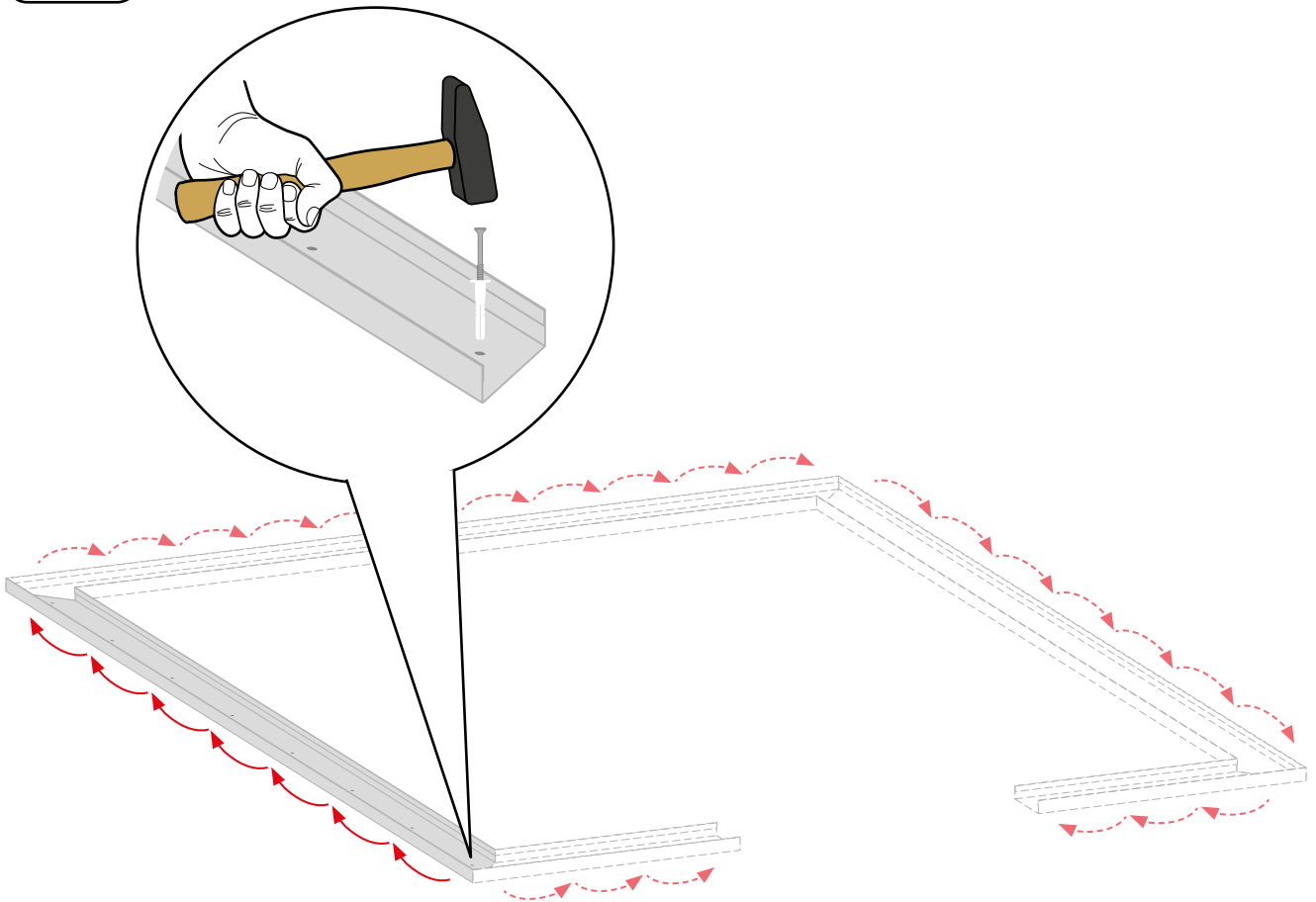

9

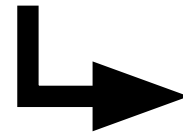
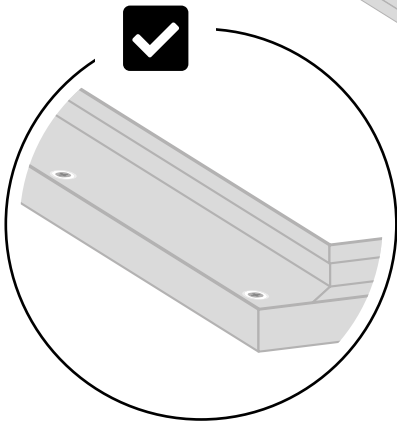
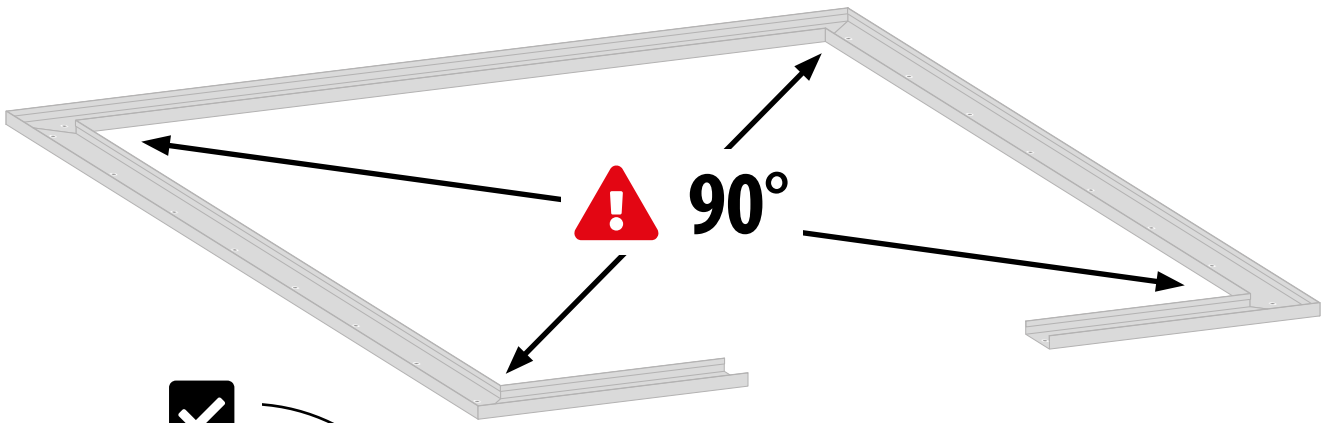

15

10

$B_1 + B_2 + \dots$

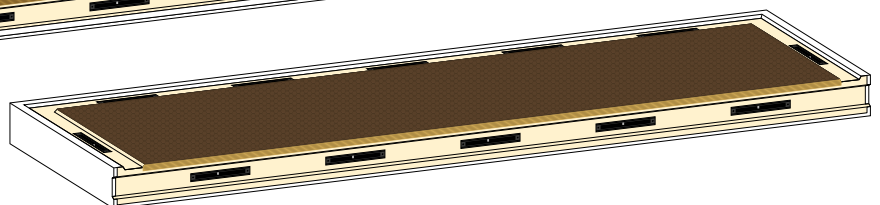
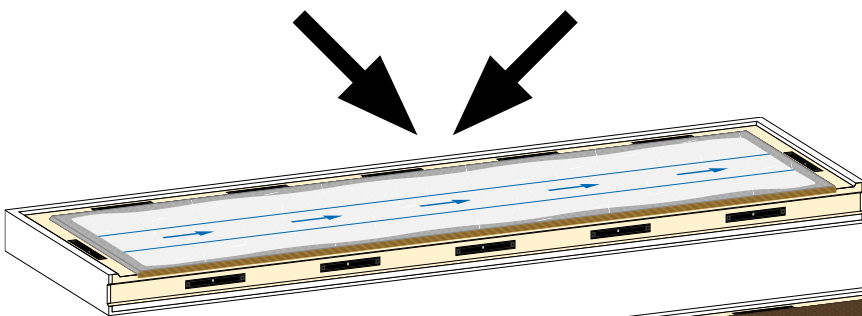
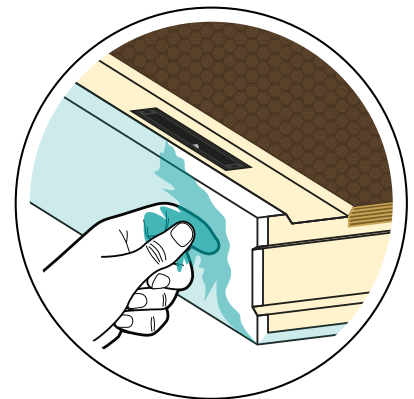
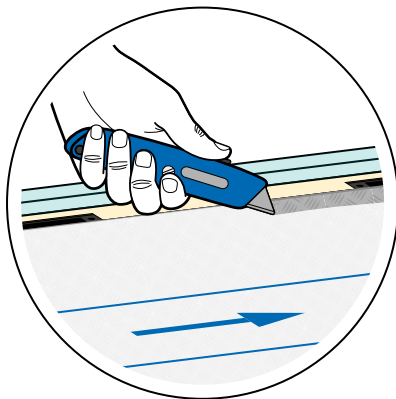
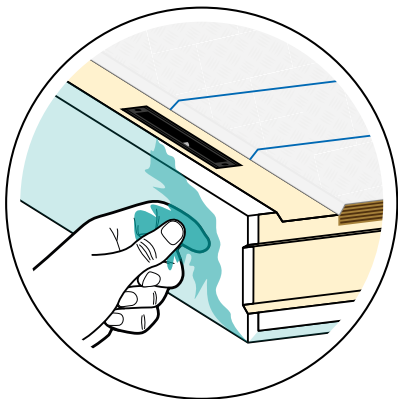

11

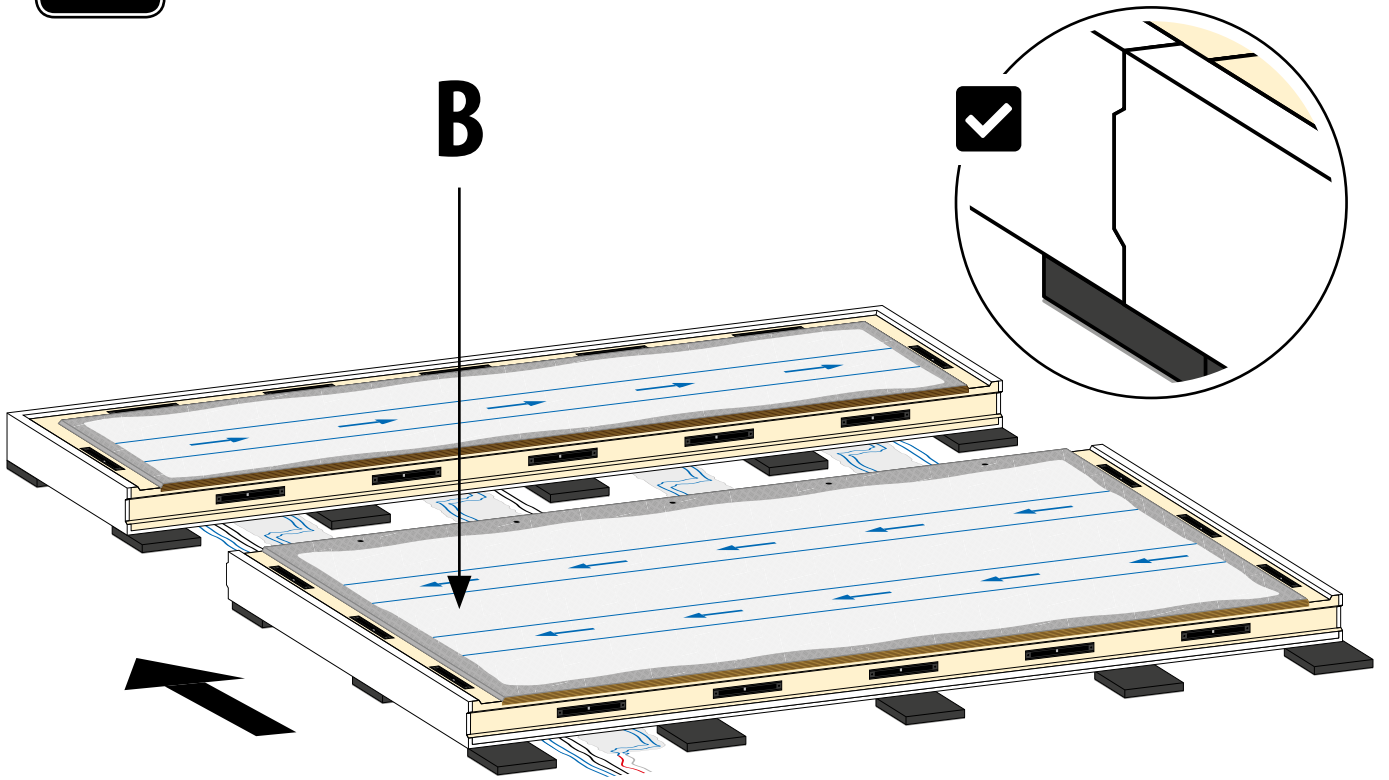

12

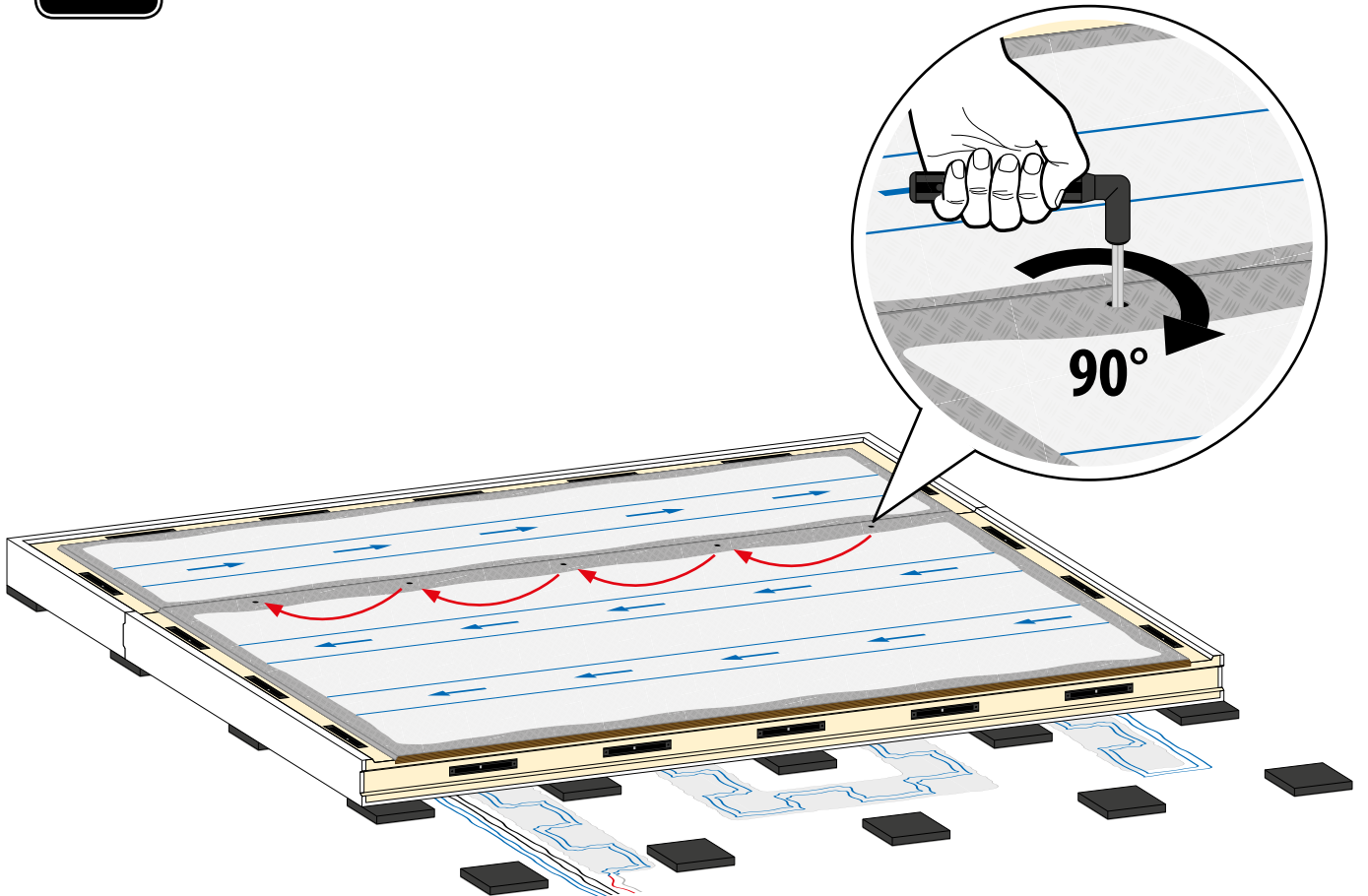

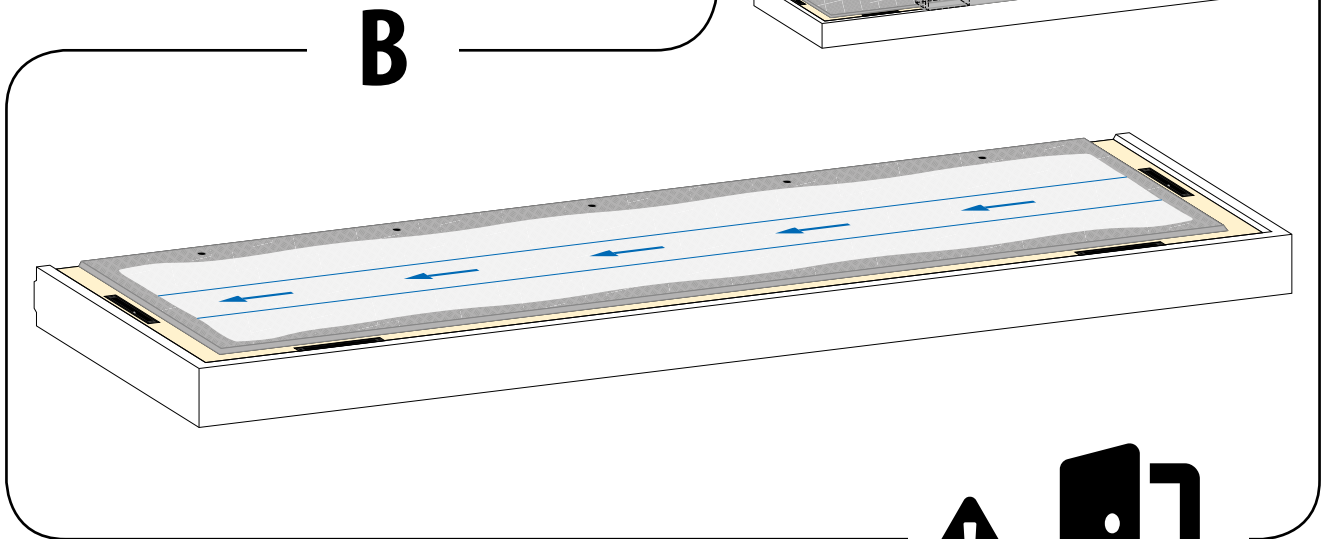
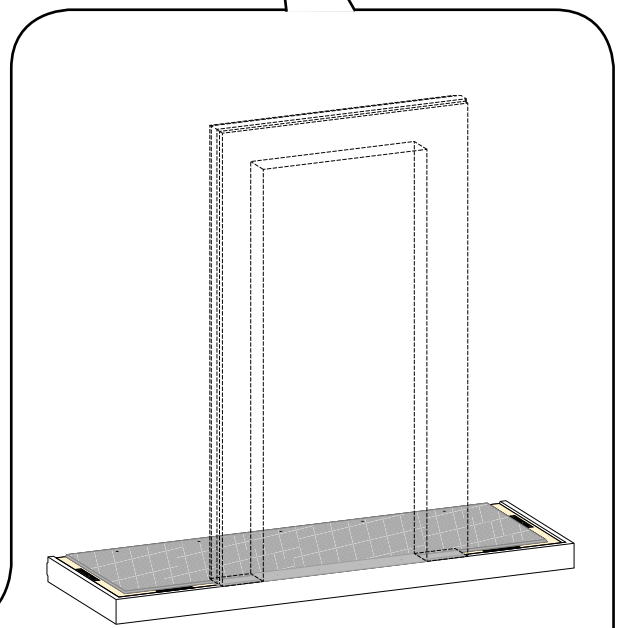
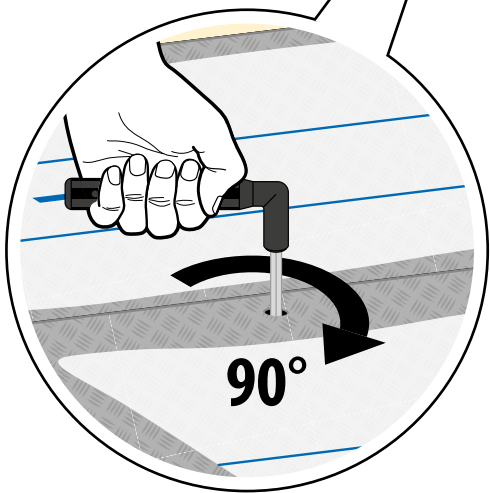
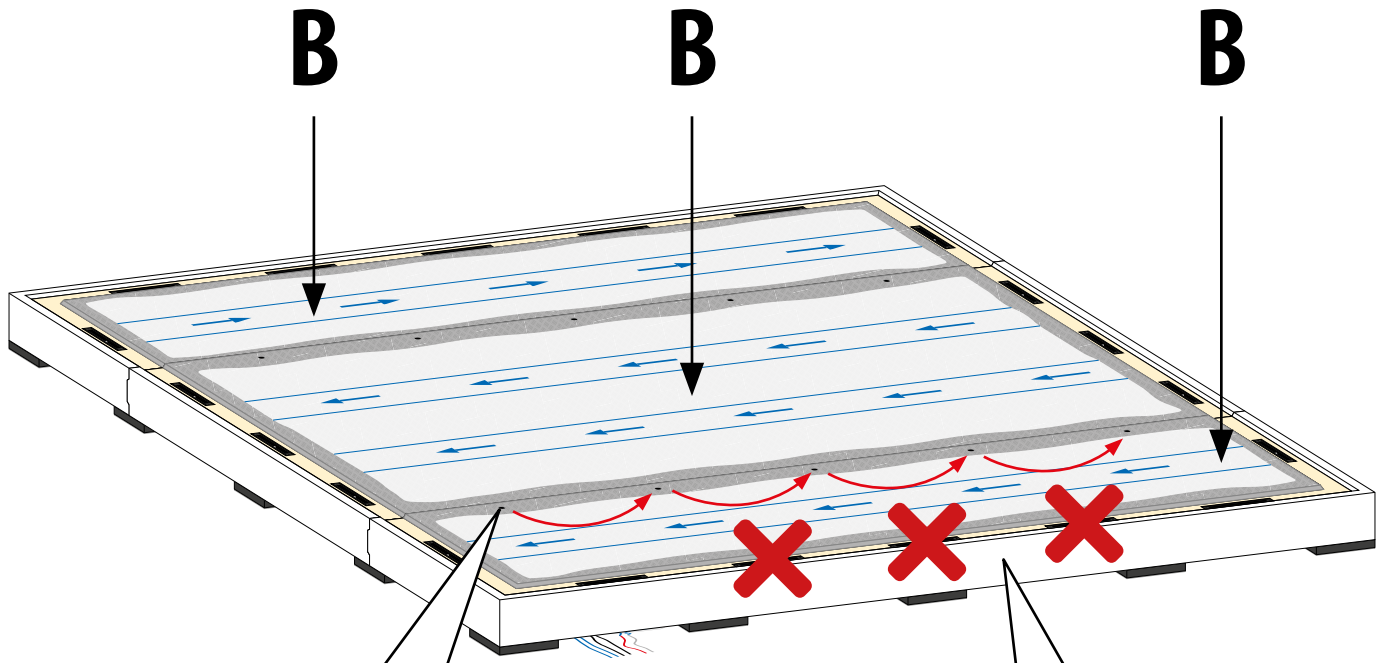

14

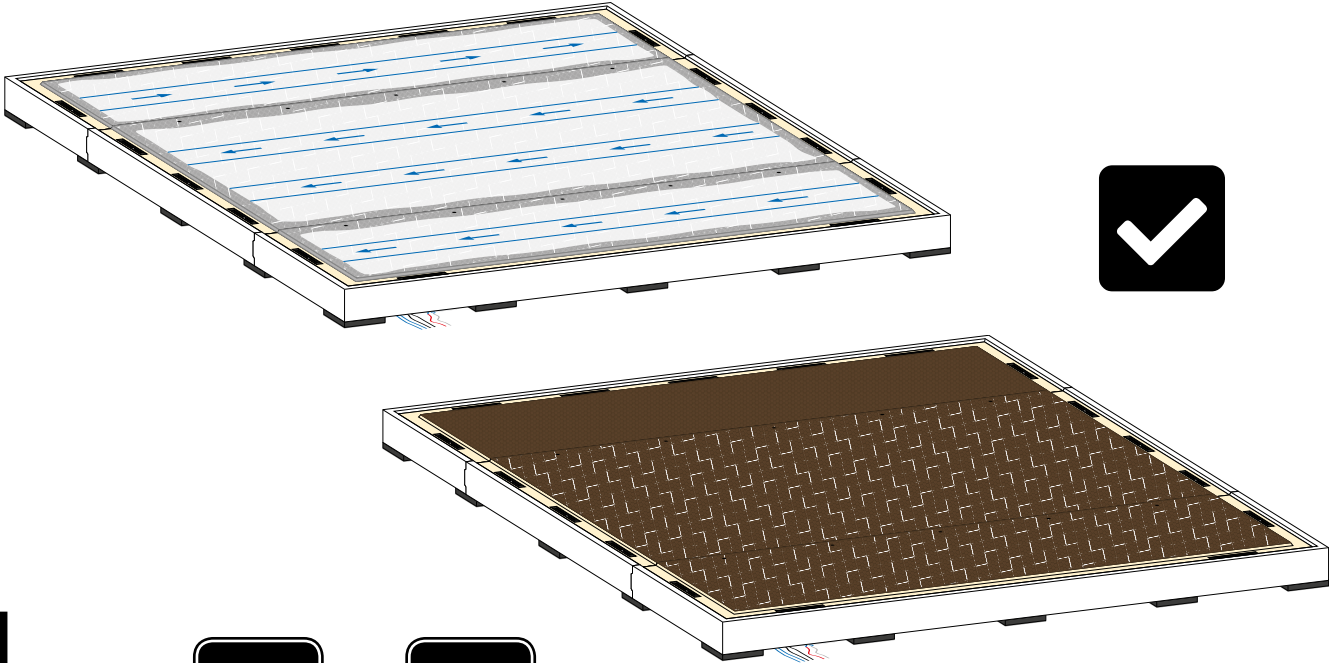

↳ 15 ▶ 18

15

W_ + D_

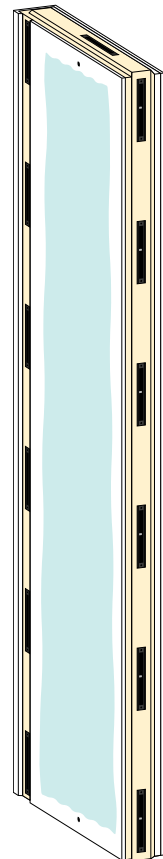

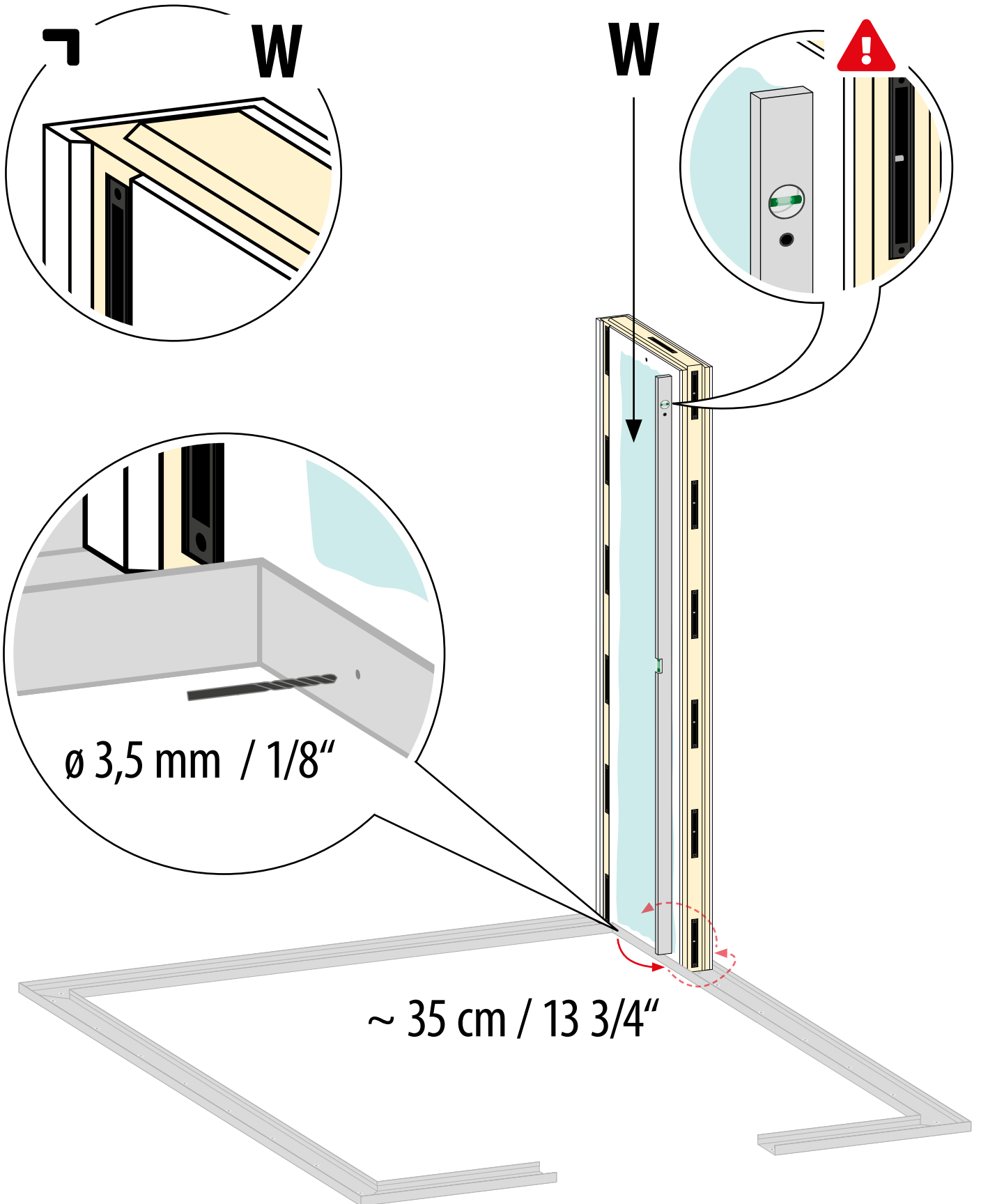

17

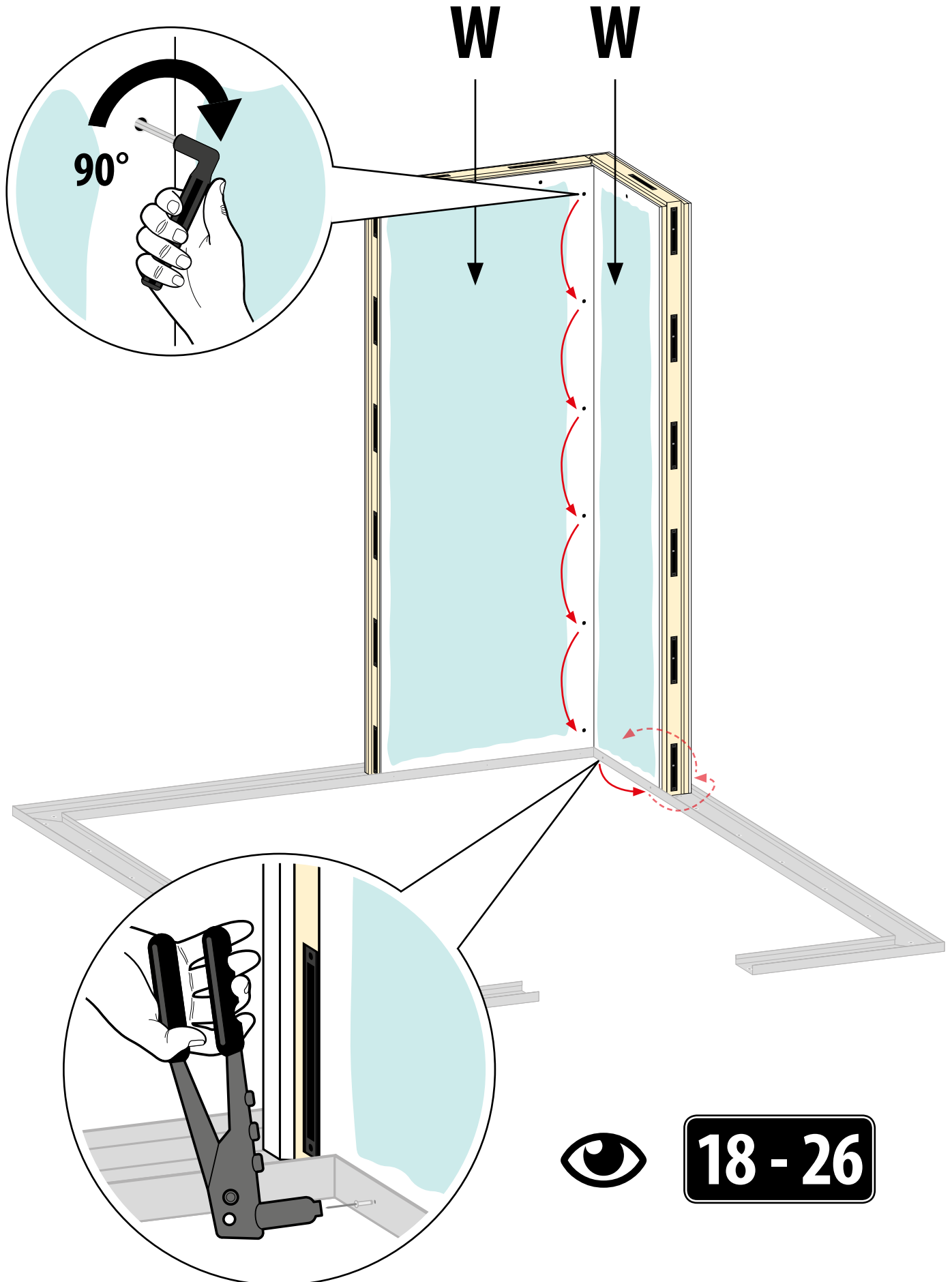

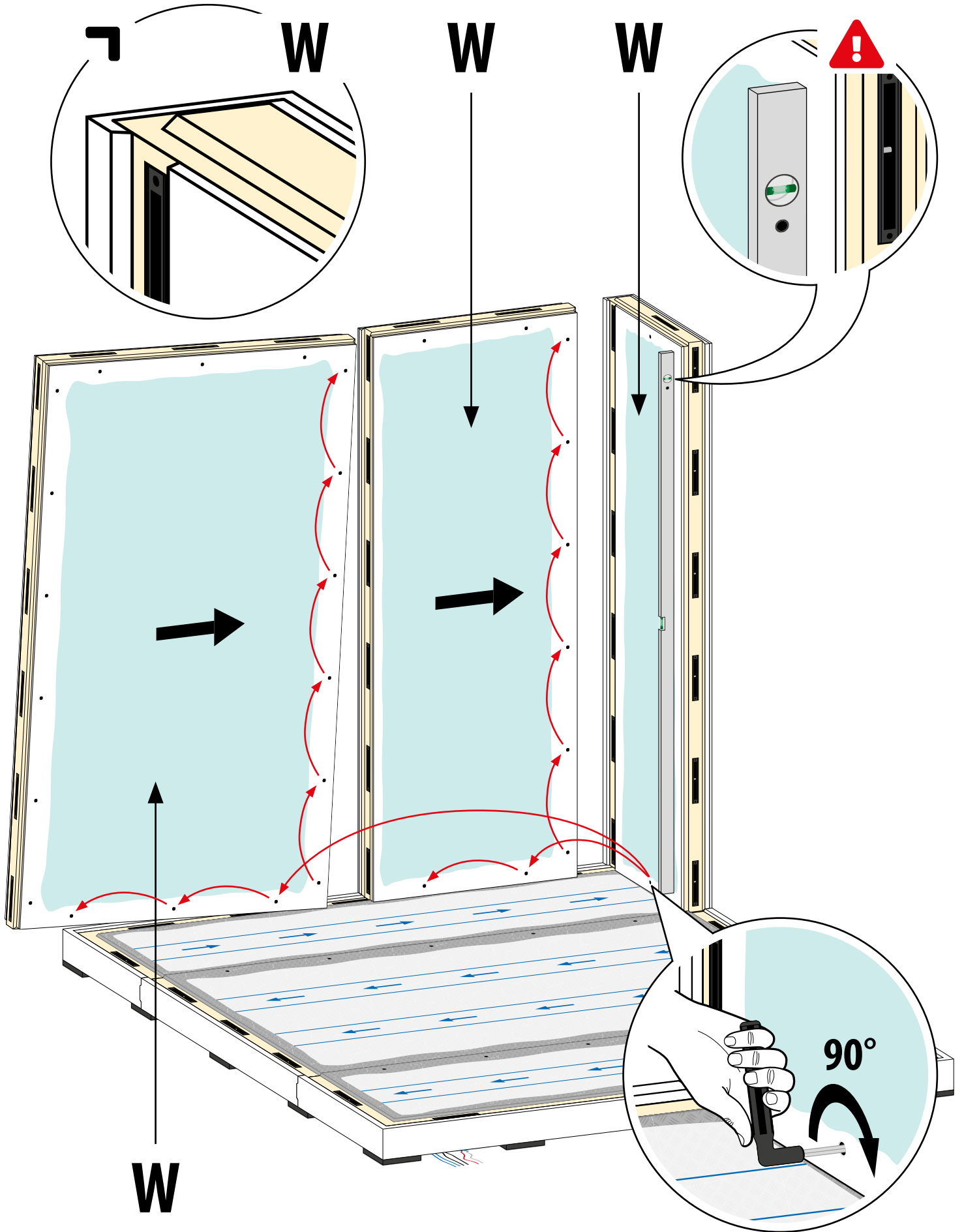

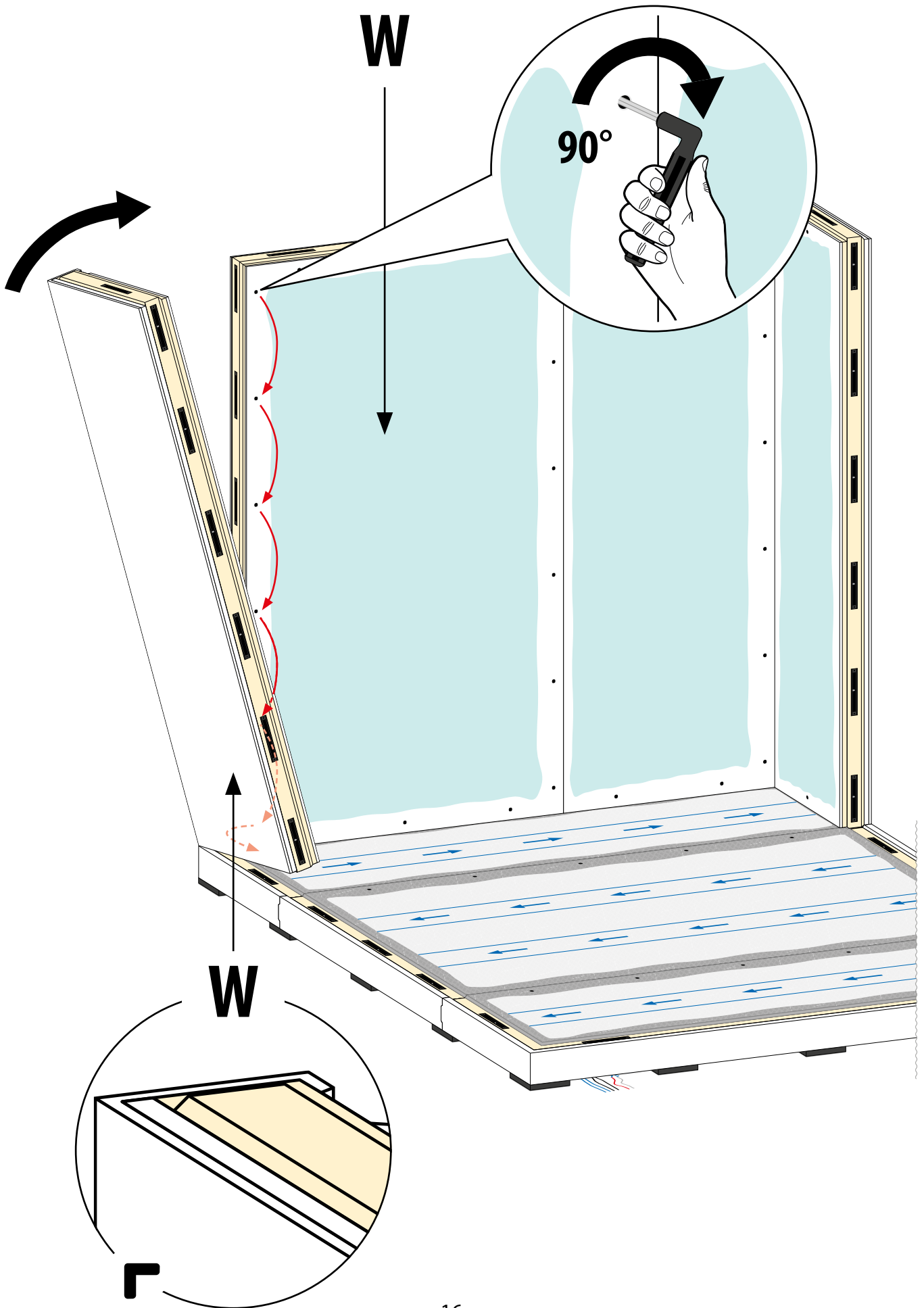

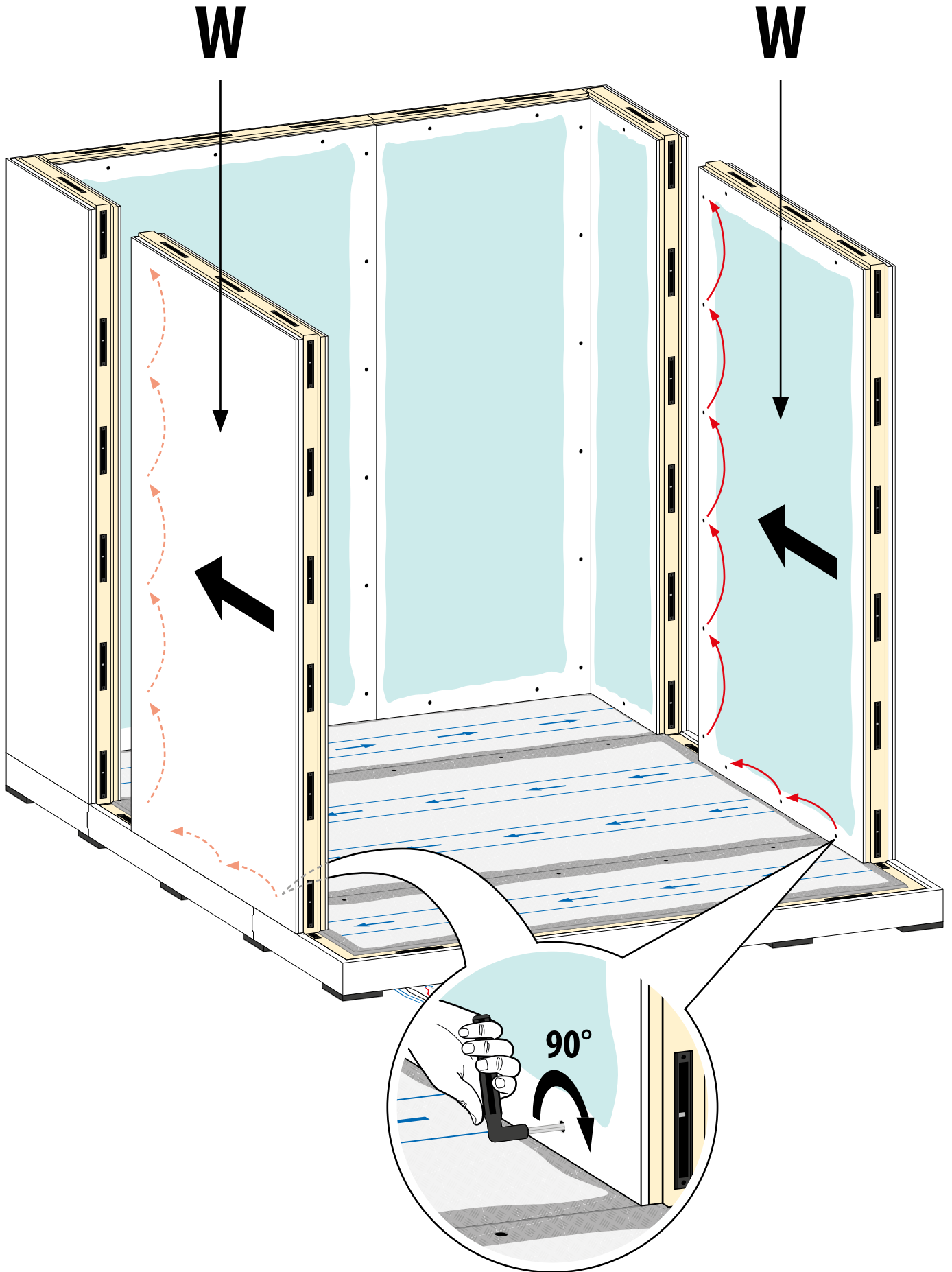

21

D

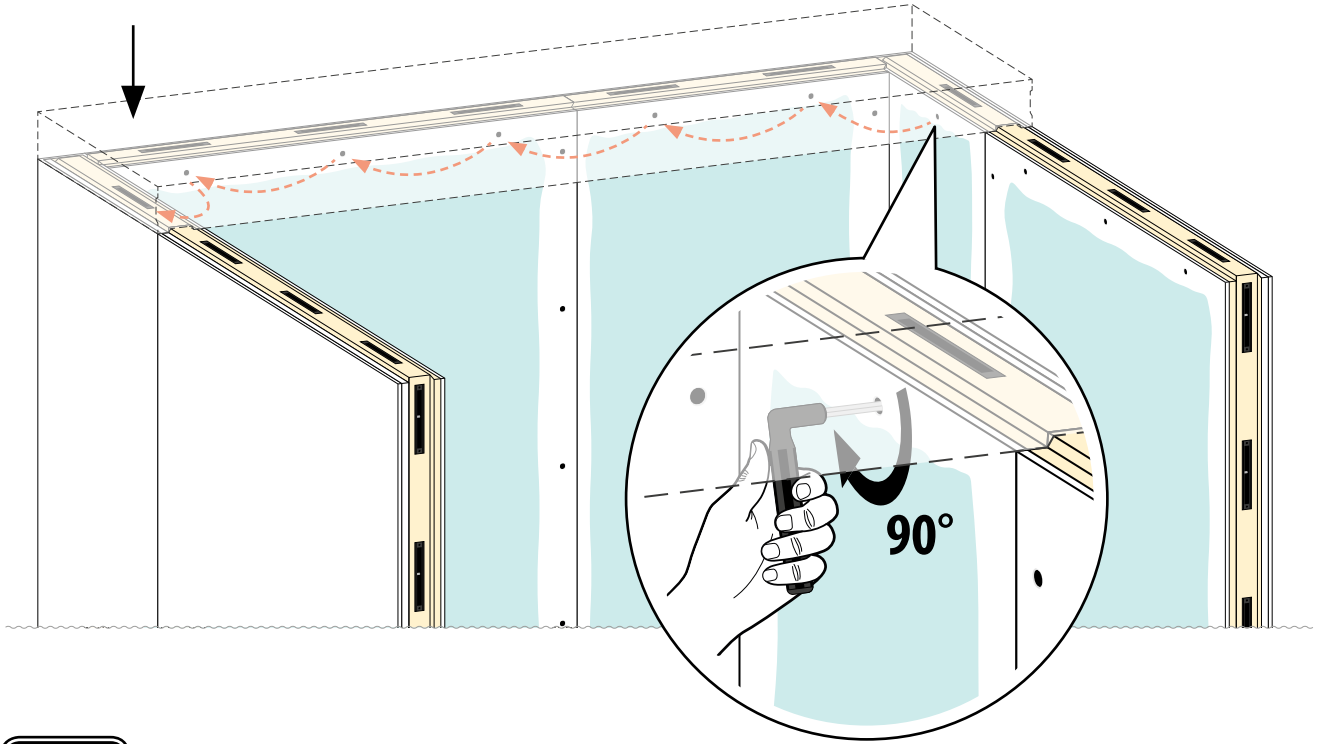

22

D

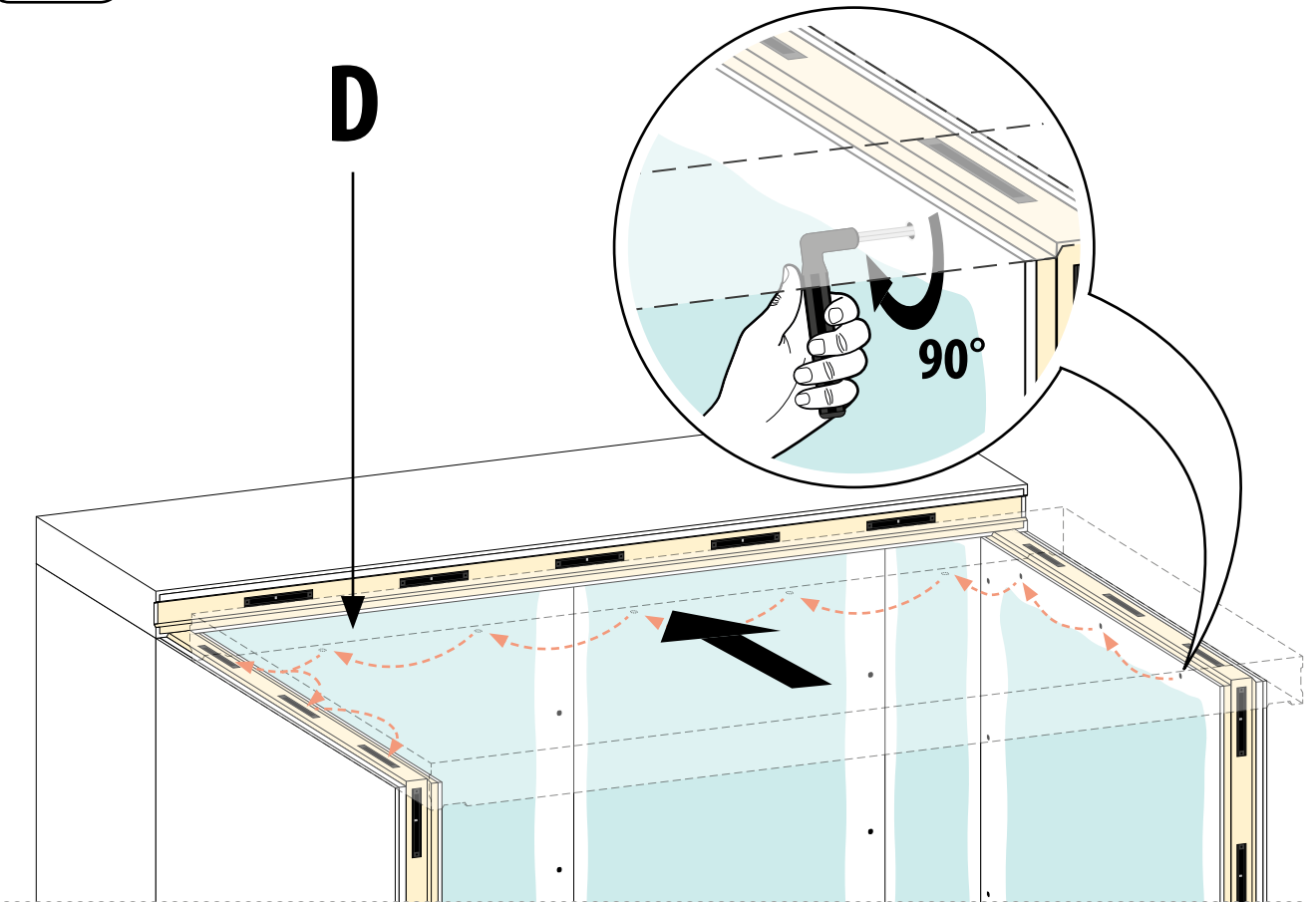

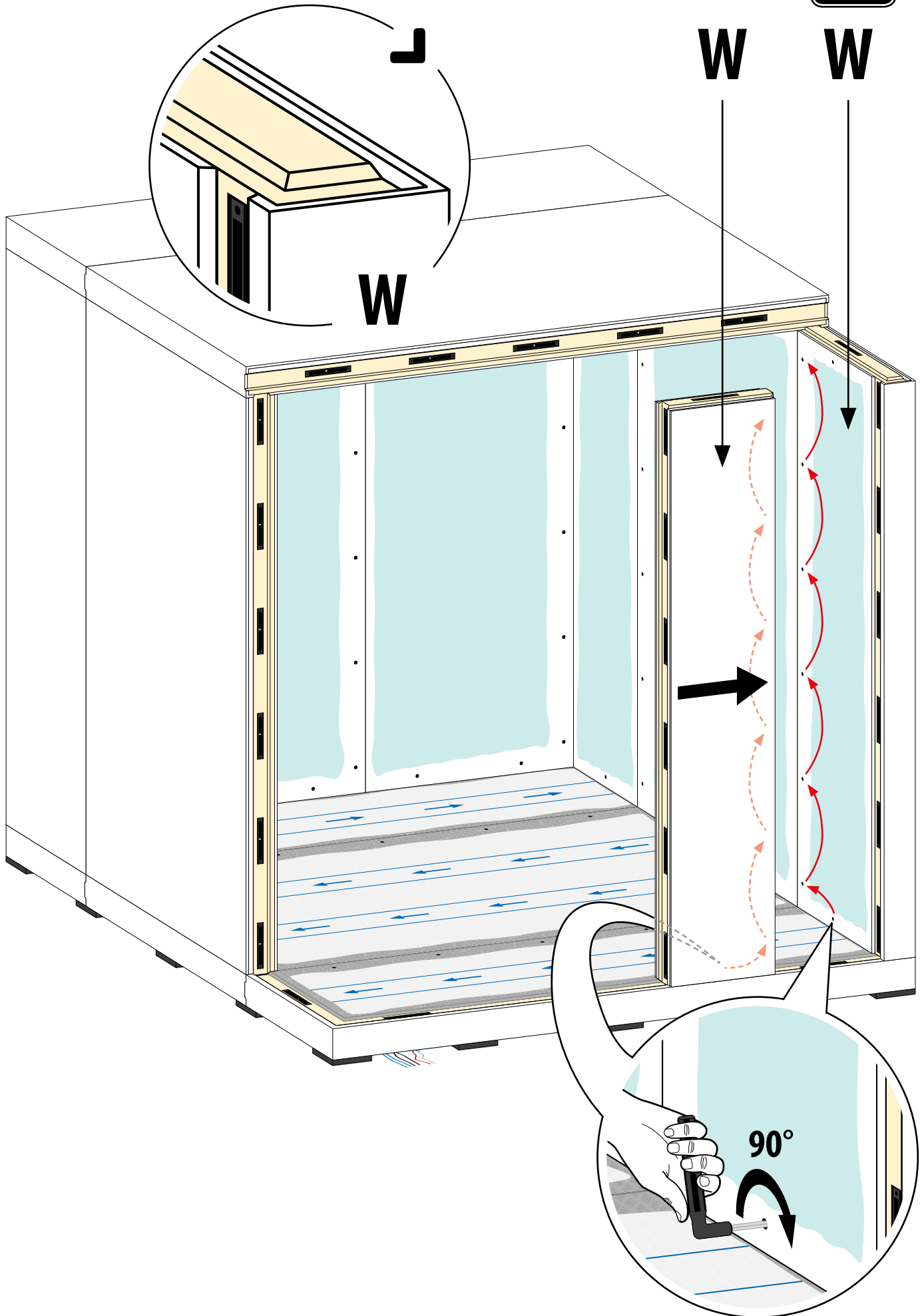

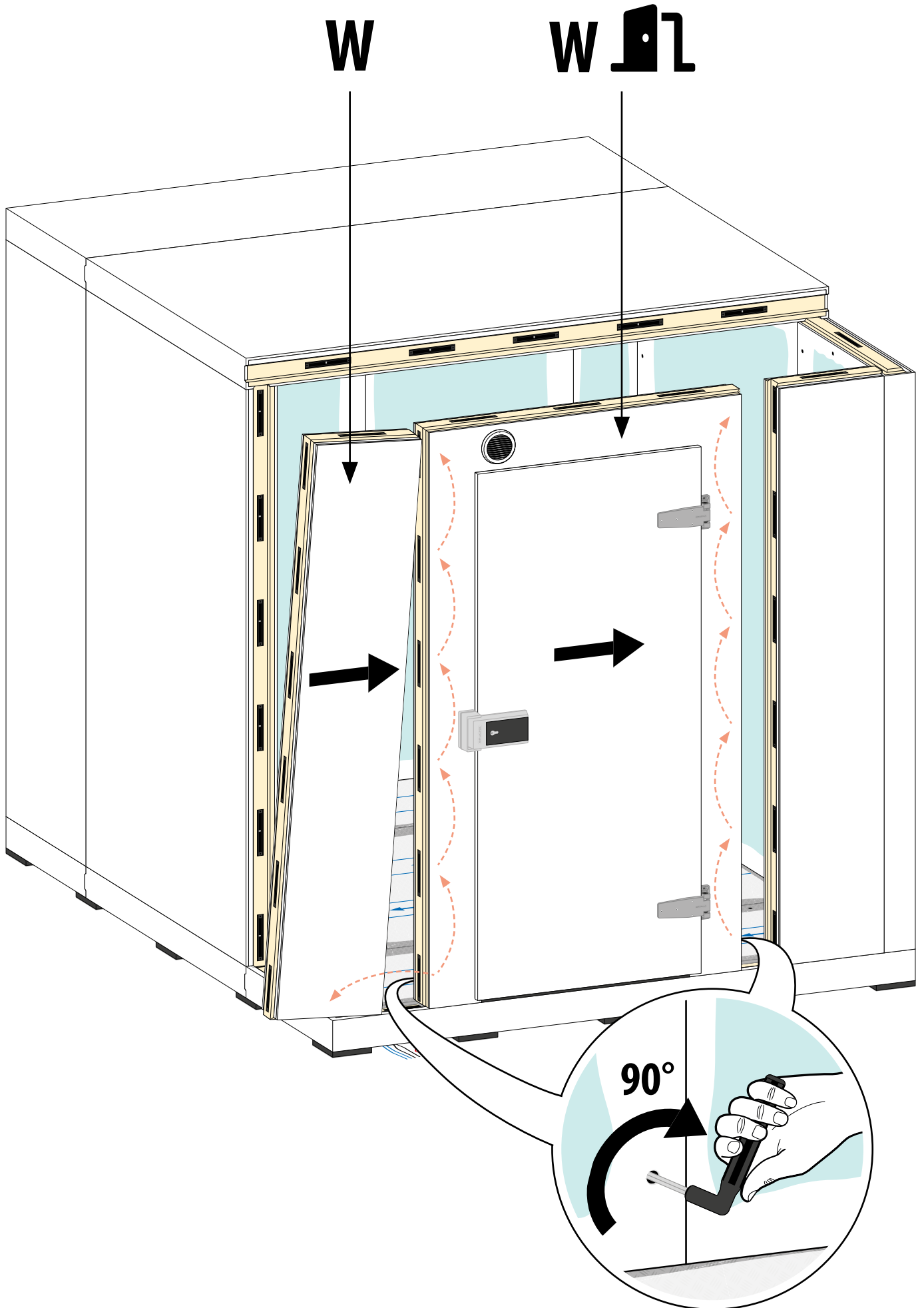

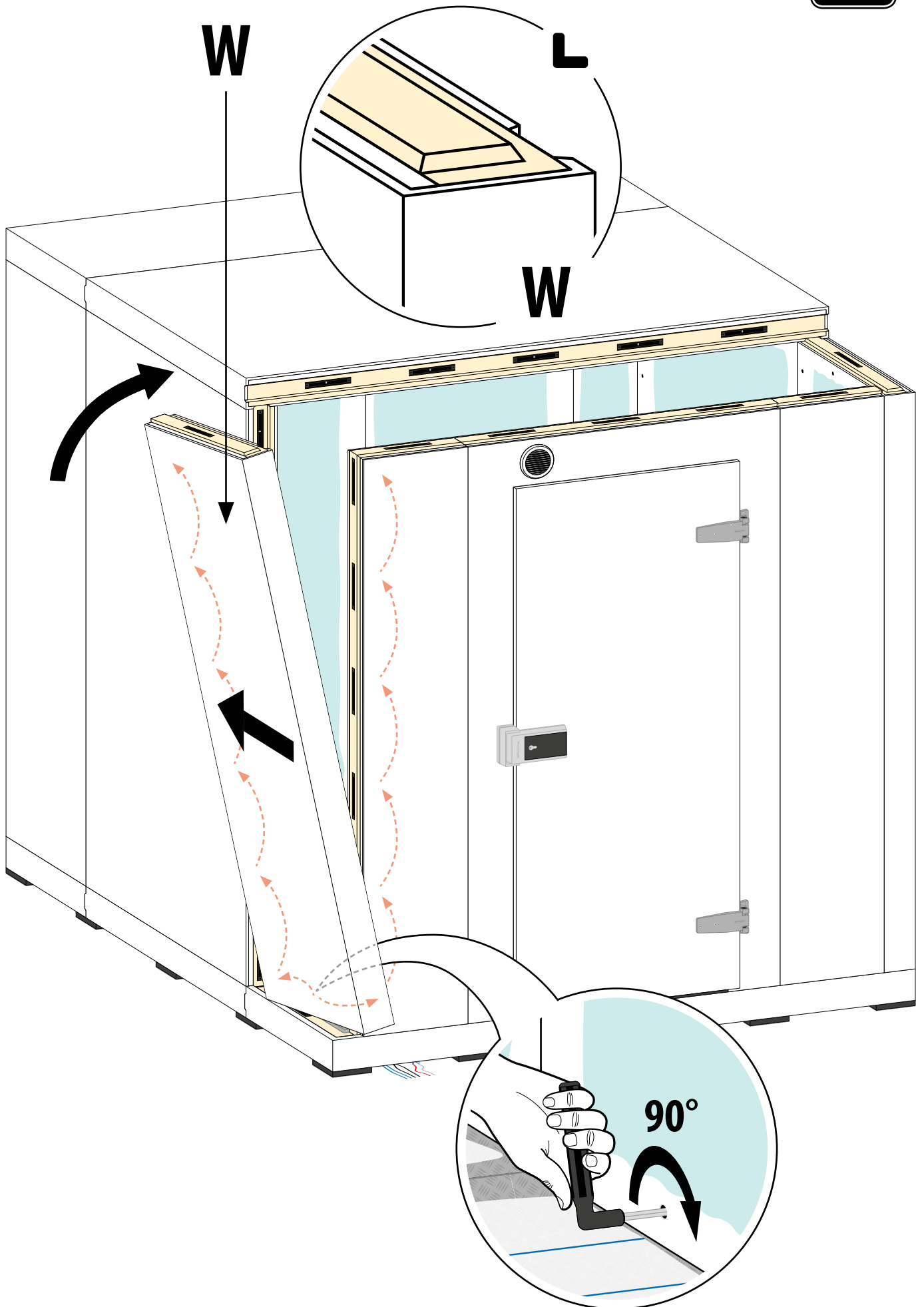

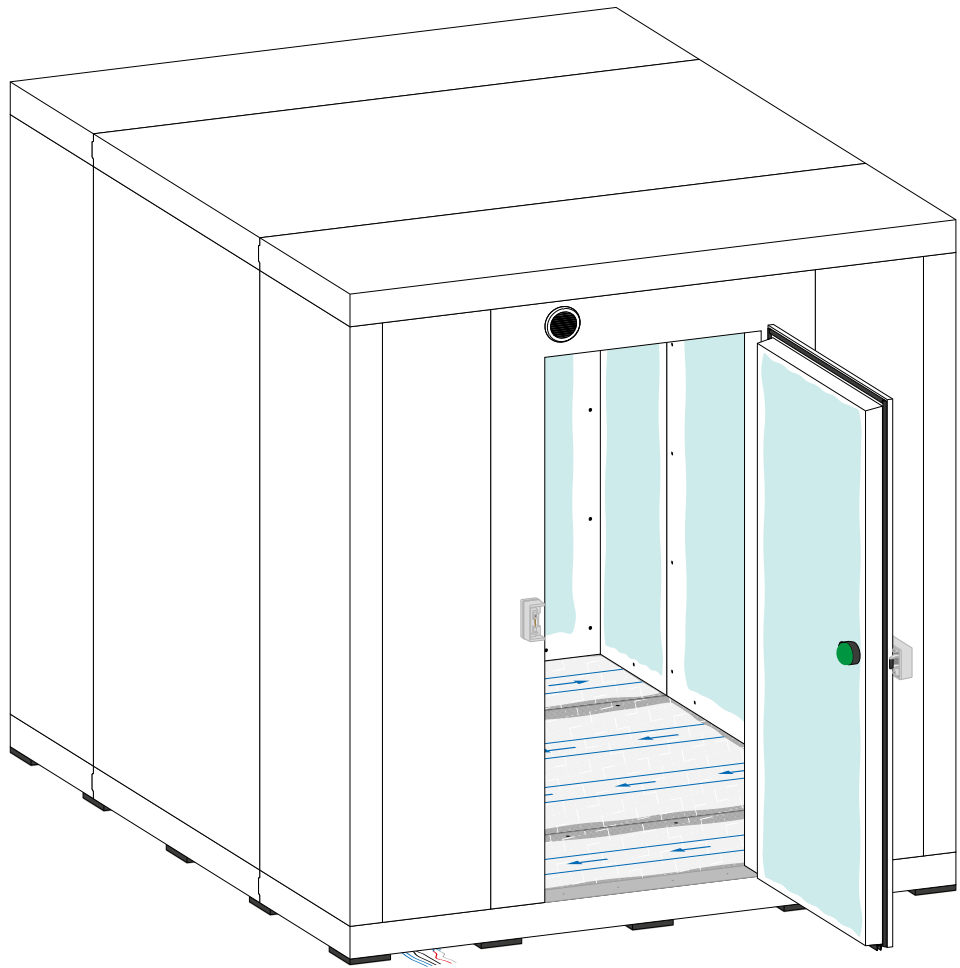
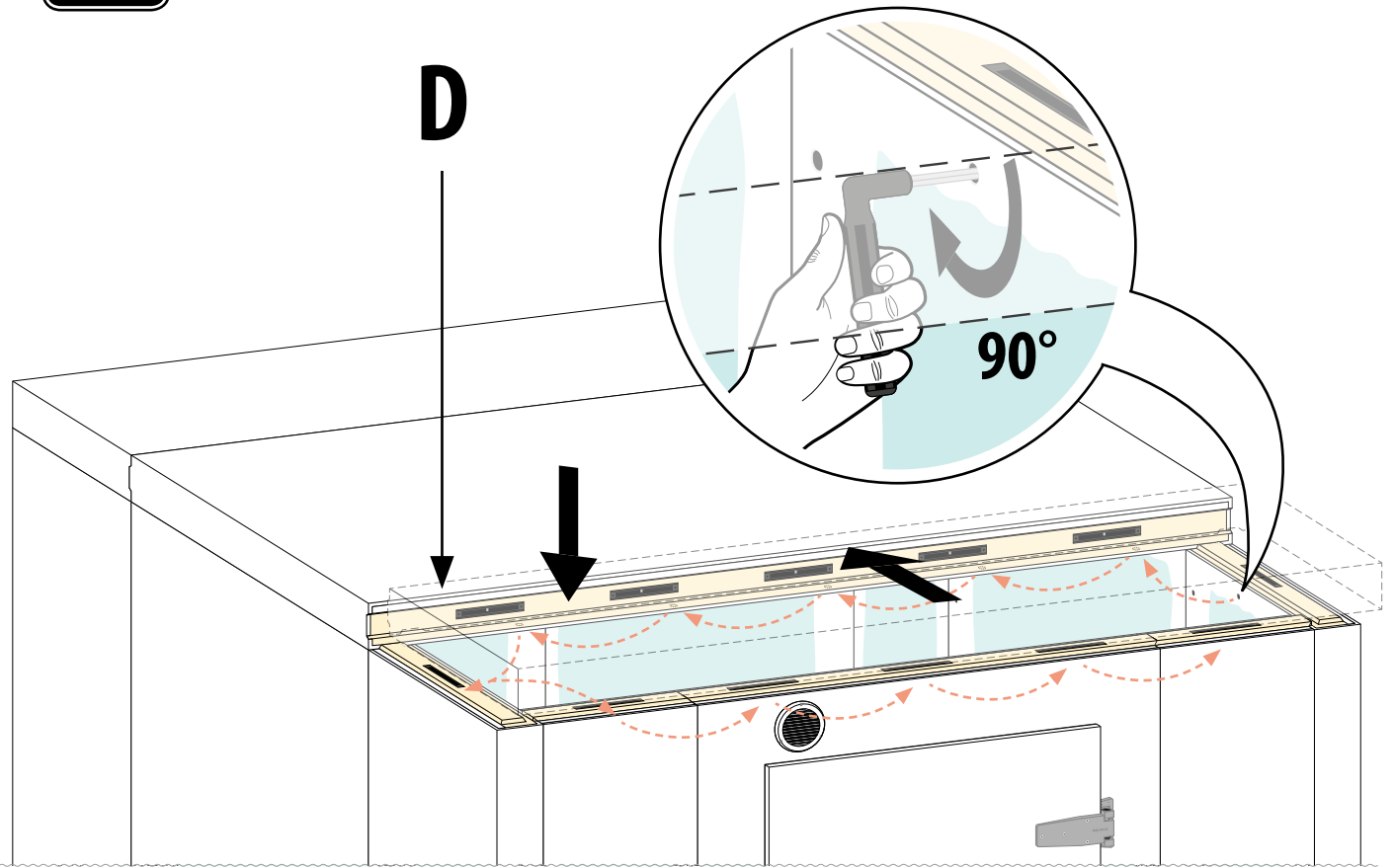

27

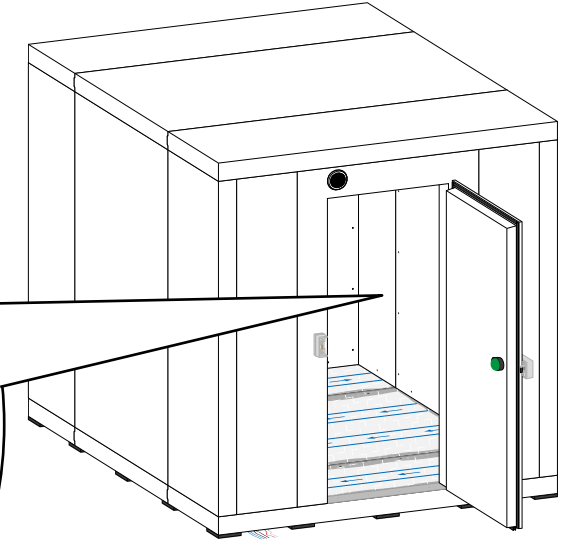
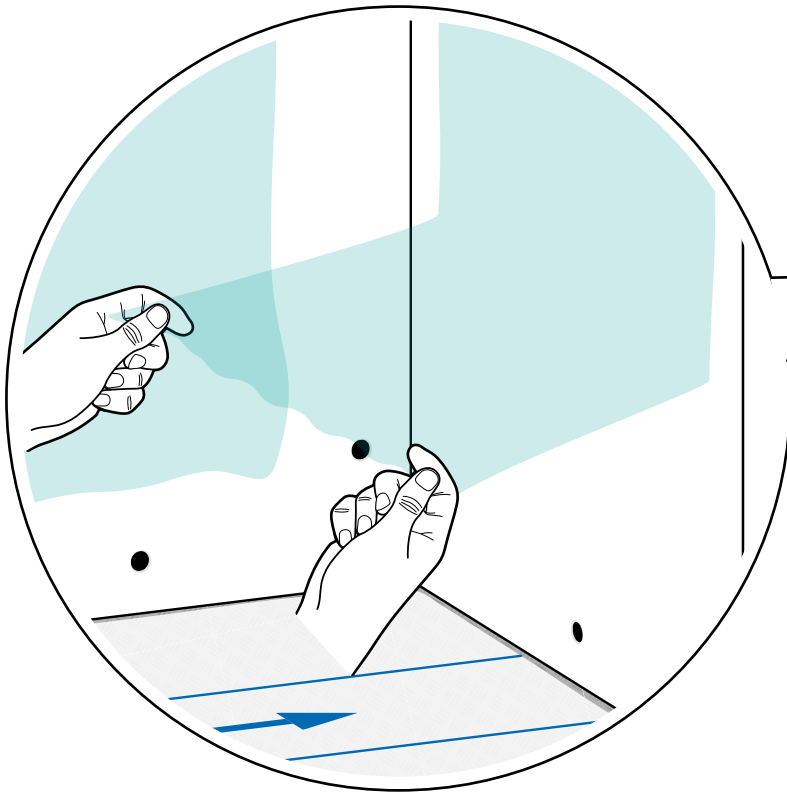

W_ + D_

28

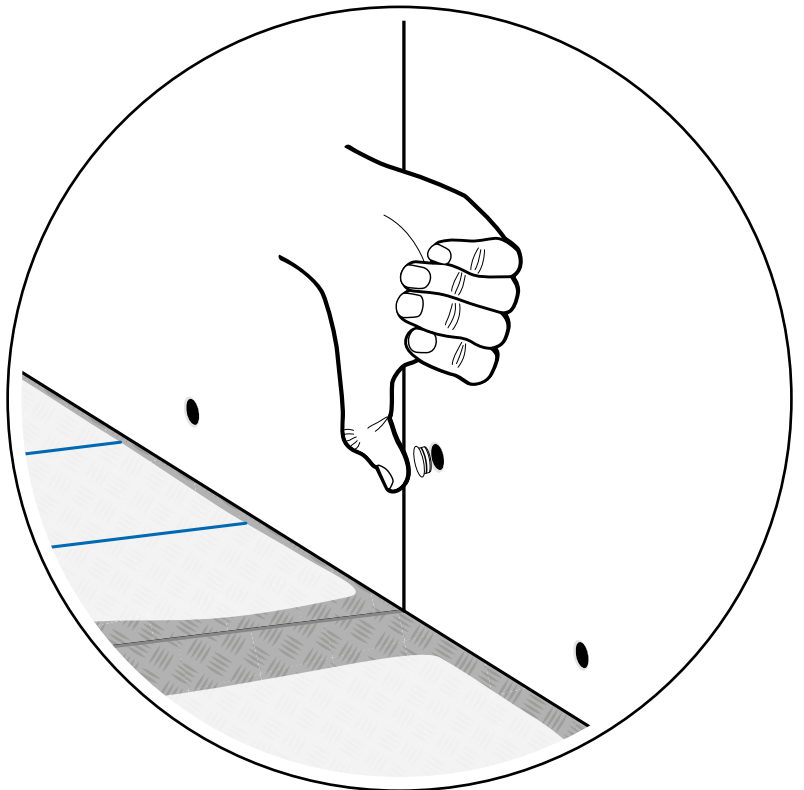

W_ + D_

29



30

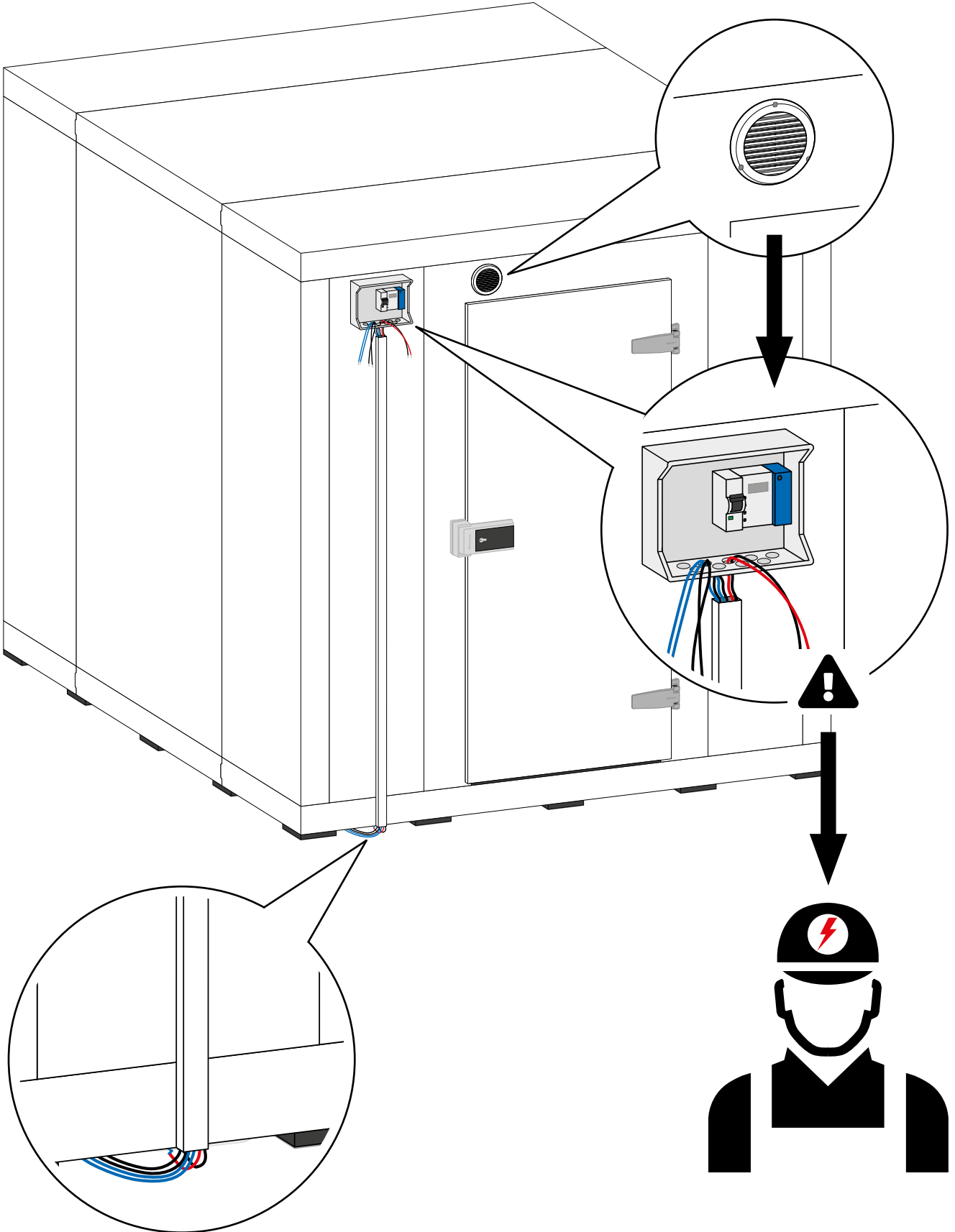

30

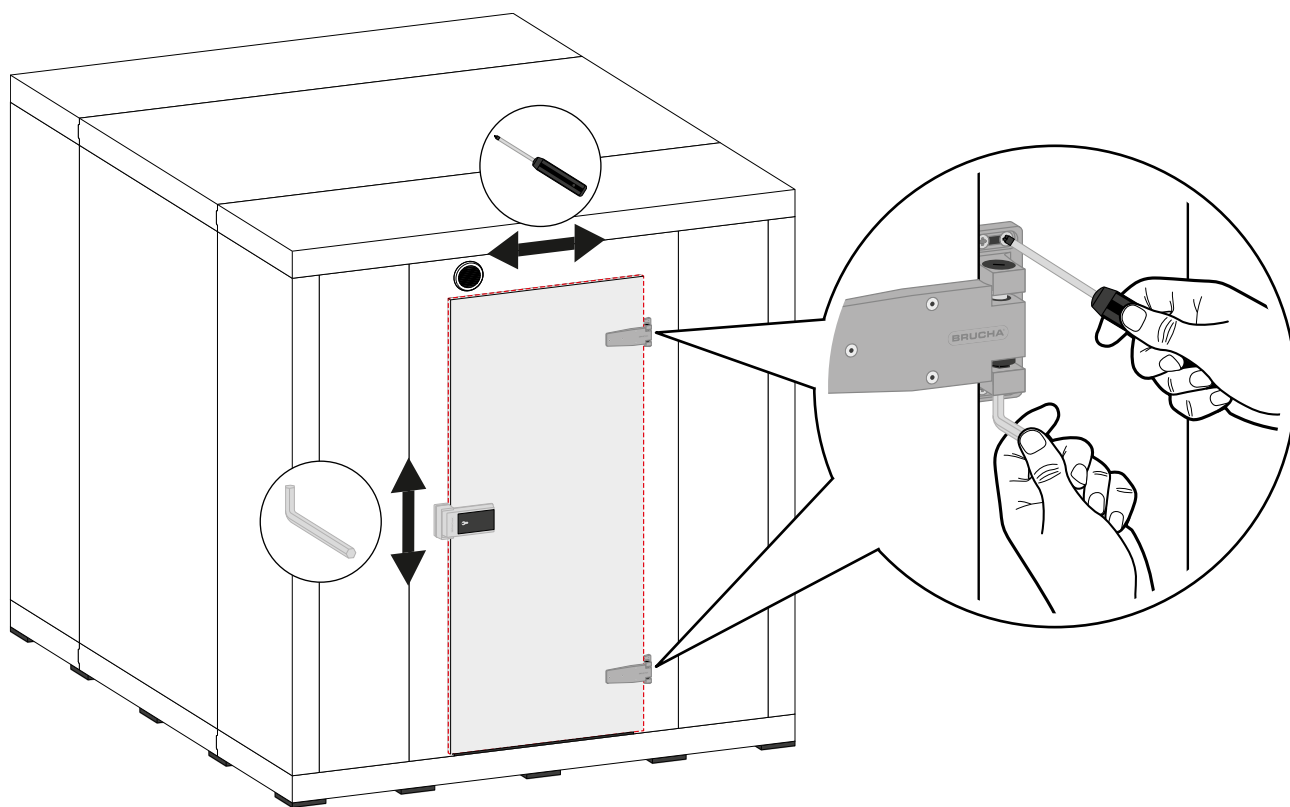

31

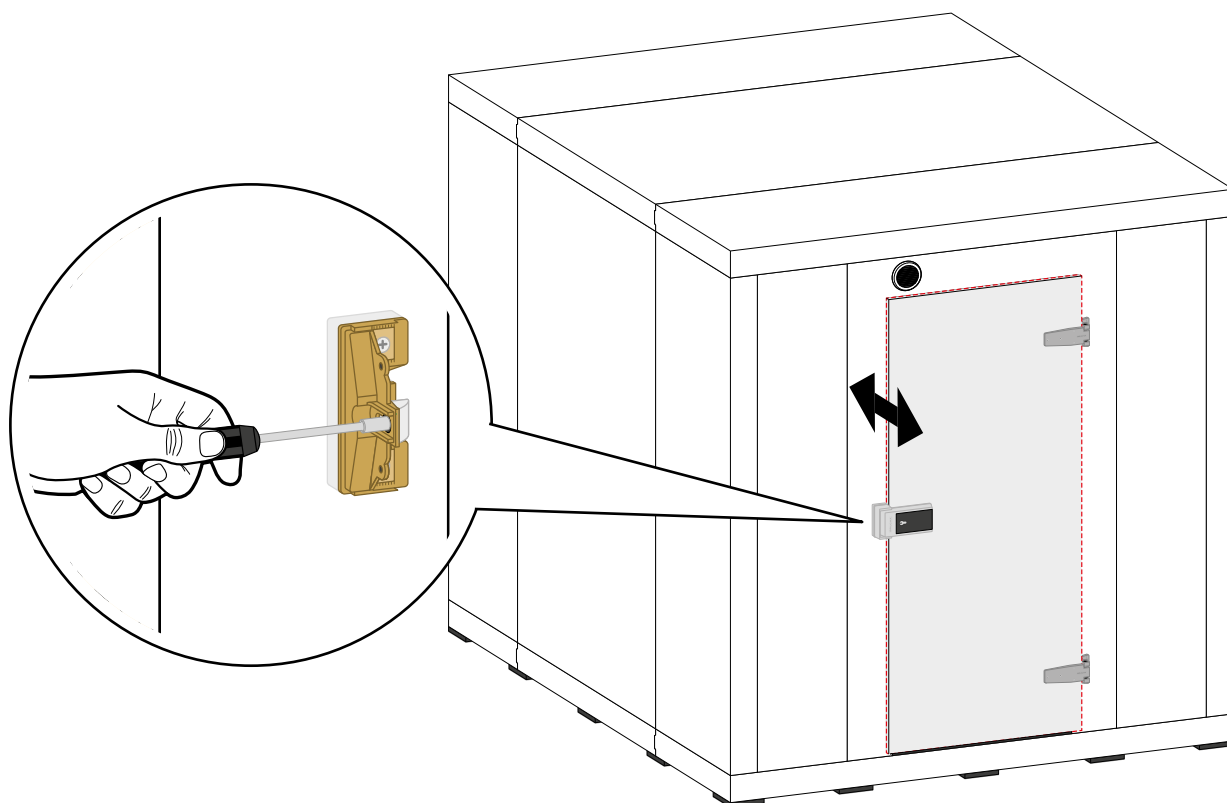

32

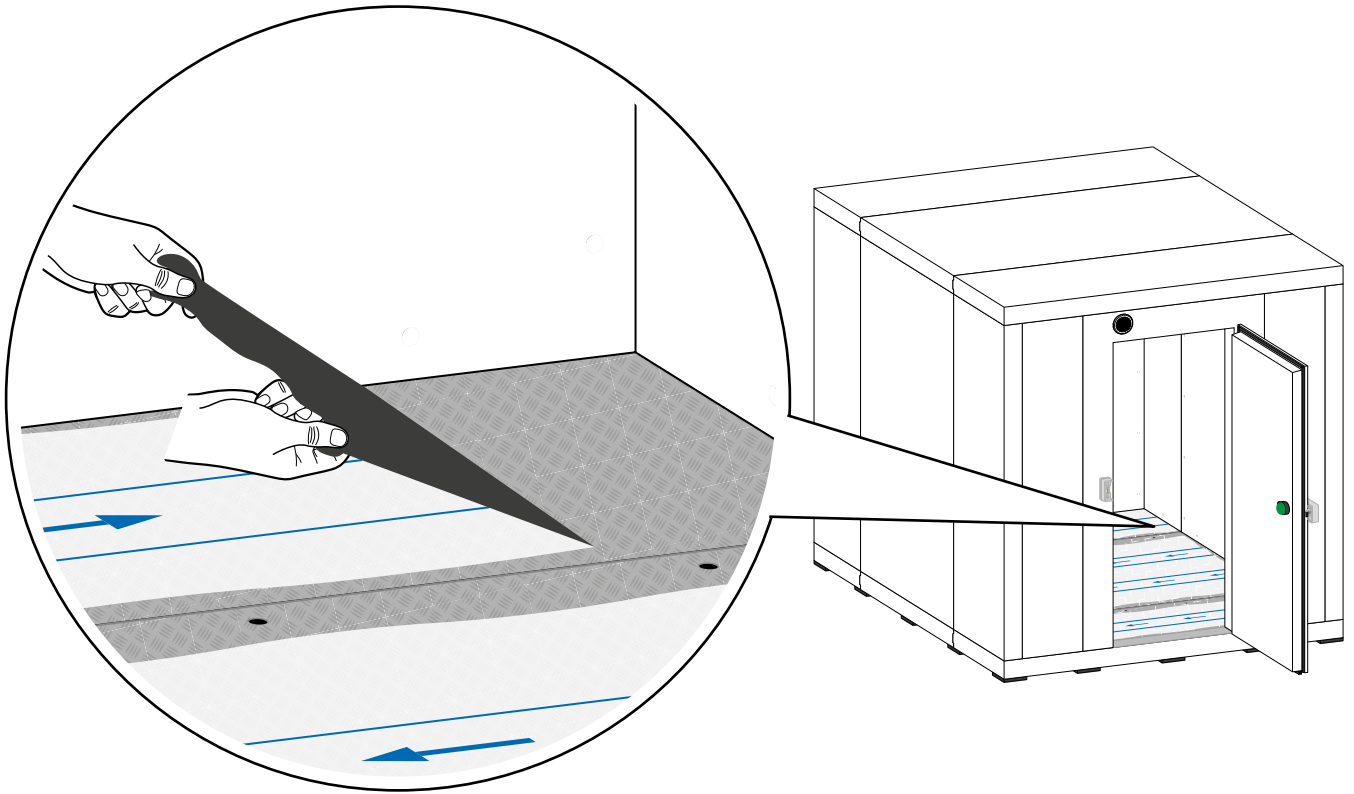

33

